



small changes  
for better life

 keden





small changes  
for better life

## Does an ecological lifestyle have to take time and sacrifice?

We want to prove that this is not the case at all. We believe in simple solutions which are of great importance. Whether it is waste segregation or living space organisation, the products of KEDEN serve both the environment and your well-being in your immediate surroundings.

## Czy ekologiczny tryb życia musi wymagać czasu i poświęceń?

Chcemy udowodnić, że wcale tak nie jest. Wierzymy w proste rozwiązania, które mają duże znaczenie. Czy chodzi o segregację odpadów, czy o organizację przestrzeni życiowej, produkty KEDEN służą zarówno środowisku, jak i Twojemu dobremu samopoczuciu w najbliższym otoczeniu.

# drobne zmiany ogromne znaczenie

Nasza filozofia jest prosta: wierzymy, że dobre nawyki w życiu codziennym pozwalają zmieniać świat. Produkty KEDEN to najlepsze rozwiązanie nie tylko dla Twojego domu i miejsca pracy, ale również dla dobra naszej planety. Są trwałymi i niezawodnymi systemami do organizacji, które pozwalają oszczędzać czas i przestrzeń. Materiały, z których zostały wykonane, nadają się w 100% do recyklingu. Dzięki temu, że zostały utrzymane w ponadczasowej, minimalistycznej estetyce, mogą służyć przez długie lata.

Porządek w Twoim otoczeniu to więcej przestrzeni dla Ciebie i Twoich pomysłów. Produkty KEDEN zostały zaprojektowane w taki sposób, żeby zajmowały jak najmniej miejsca, a jednocześnie były wygodne w użytkowaniu. Dzięki temu codzienna segregacja odpadów nie jest ani uciążliwa, ani czasochłonna. Chcemy pomóc Ci żyć w przyjazny dla środowiska sposób i dobrze wiemy, że można zrobić to w zgodzie z Twoimi potrzebami.

Dobre nawyki to lepsze i uważniejsze życie. Chcemy pomóc Ci je wprowadzić. Wystarczy drobne zmiany, aby zbudować zrównoważoną przyszłość.

# small changes for better life

Our philosophy is simple: we believe that good habits in everyday life make it possible to change the world. The products of KEDEN are the best solution not only for your home and workplace, but also for the welfare of our planet. They are durable and reliable organisable systems which allow you to save time and space. The materials from which they are made are 100% recyclable. Due to the fact that they have been kept in timeless, minimalistic aesthetics, they can be used for many years.

Order in your surroundings means more space for you and your ideas. The products of KEDEN have been designed in such a way that they take up as little space as possible and are also easy to use. Thanks to this, the daily segregation of waste is neither burdensome nor time-consuming. We want to help you live in an environmentally friendly way and we know very well that it can be done according to your needs.

Good habits mean a better and more mindful life. We want to help you introduce them. Small changes are enough to build a sustainable future.



# Index



Compacta Q  
p. 10-11



Compacta R  
set  
p. 17



Systema  
p. 26-27



Systema  
p. 30-31



Systema  
p. 33



Systema  
p. 36-37



Compacta Q  
Basic  
p. 12-13



Compacta Q  
Duo  
p. 18-19



Systema  
p. 28-29



Systema  
p. 30-31



Systema  
p. 33



Systema  
p. 36-37



Compacta Q  
p. 14



Compacta Q  
Duo  
p. 20-21



Systema  
p. 28-29



Systema  
Basica  
p. 32



Systema  
p. 34-35



Systema  
p. 38-39



Compacta Q  
set  
p. 15



Compacta Q  
Duo  
p. 20-21



Systema  
p. 28-29



Systema  
Basica  
p. 32



Systema  
p. 34-35



Systema  
p. 38-39



Compacta R  
p. 16



Systema  
p. 26-27



Systema  
p. 30-31



Systema  
Basica  
p. 32



Systema  
p. 36-37



Systema  
p. 38-39



Sortibox  
p. 40-41



Wheeler  
p. 52-53



Dry pad  
p. 58-59



Nuk  
p. 68-71



Sortibox  
p. 42-43



Smooth  
p. 54-55



Lucy  
p. 60-61



Nuf low  
p. 72-73



Sortibox  
p. 44-45



Titan  
p. 56-57



Lily  
p. 62-63



Nuf high  
p. 74-75



Sortibox  
p. 46-49



Spacyshoe  
p. 58-59



Billy  
p. 64-65



Line  
p. 76-77



Sortibox  
p. 50-51



Spacyshoe  
p. 58-59



Cargobox  
& Cargolid  
p. 66-67

Explore Our Brands  
p. 78-97



Skeden



 keden

waste bin



easy sorting of household waste  
perfect organiser



waste bin

## Compacta Q



Compacta Q

Compacta Q is a practical bin that has been adapted to the various needs of users. It has a lid that opens in two ways - it can be tilted or opened, depending on what is more convenient. The aesthetic frame, available in various colours, not only effectively protects the bin bag against slipping, but also facilitates waste segregation.

Praktyczny kosz Compacta Q został dostosowany do różnorodnych potrzeb użytkowników. Wyposażony jest w klapę, która otwiera się na dwa sposoby - można ją uchylić lub otworzyć, zależnie od preferencji. Jego estetyczna, dostępna w różnych kolorach ramka nie tylko skutecznie zabezpiecza worek przed osunięciem, ale też ułatwia segregację odpadów.



compacta Q	NSAB12	NSAB25	NSAB45
size [ l x w x h ]	260 x 195 x 370 mm	296 x 264 x 526 mm	394 x 298 x 612 mm
volume	12 L	25 L	45 L
packaging	i	i	i
pallet quantity	i	i	i
pallet height	i	i	i
colour	1215C  WG5C 2717C  5575C 429U	1215C  WG5C 2717C  5575C 429U	1215C  WG5C 2717C  5575C 429U



easy sorting of household waste  
perfect organiser

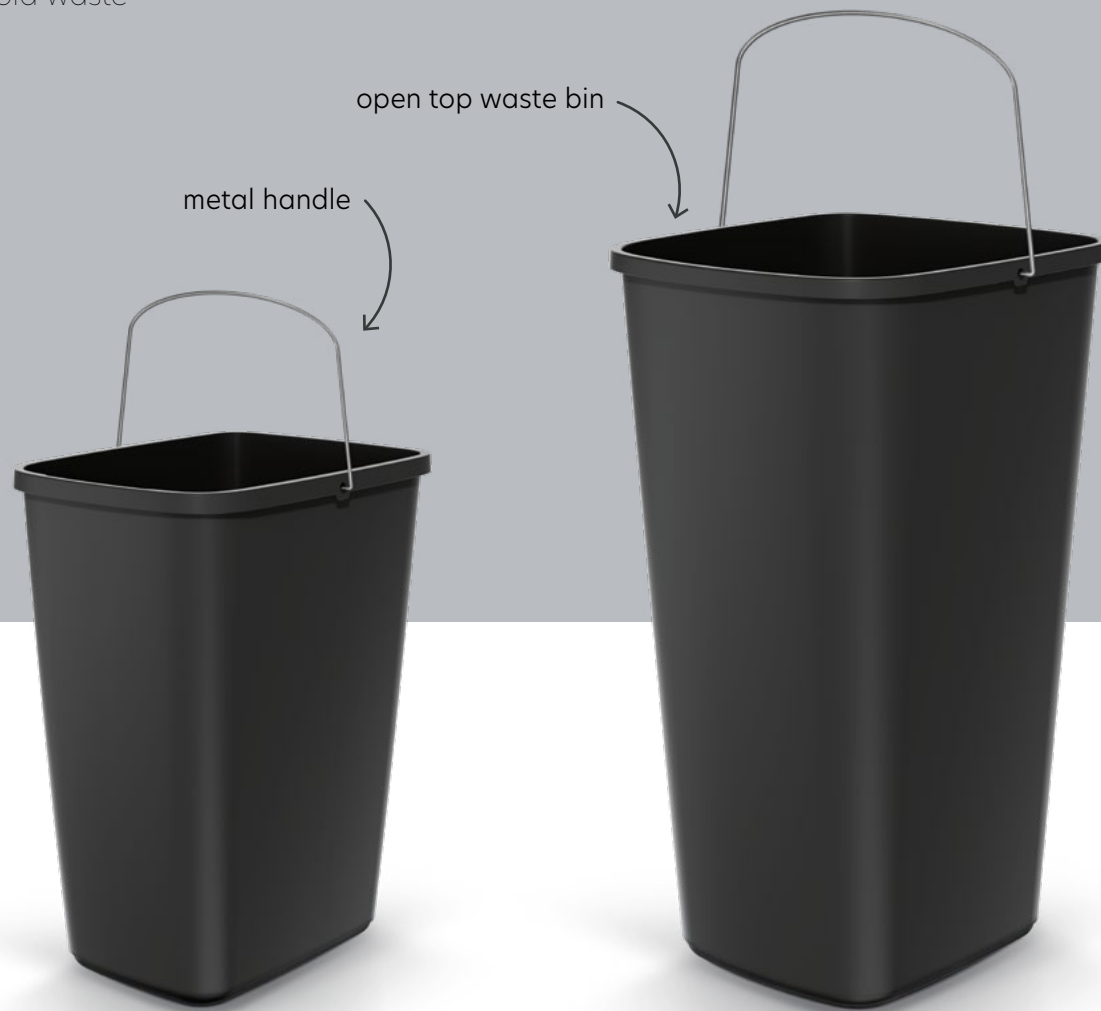

waste bin



## Compacta Q basica



Compacta Q basic is a practical bin that has been adapted to the various needs of users. Thanks to the solid, metal handle, it is easy to carry and the smoothly finished interior makes it easy to clean. The model is available in two sizes 12 and 25 litres, so it meets the individual needs of the users.

Praktyczny kosz Compacta Q został dostosowany do różnorodnych potrzeb użytkowników. Dzięki solidnej, metalowej ręczce jest łatwy w przenoszeniu, a gładko wykończone wnętrze ułatwia jego czyszczenie. Model występuje w dwóch rozmiarach 12 oraz 25 litrów, dzięki czemu odpowiada na indywidualne potrzeby użytkownika.



Compacta Q  
basica



compacta Q basic	NSAB12U	NSAB25U
size [ l x w x h ]	253 x 195 x 337 mm	287 x 264 x 490 mm
volume	12 L	25 L
packaging	i	i
pallet quantity	i	i
pallet height	i	i
colour	● S411* 	● S411* 

# Compacta Q

A rectangular bin with smoothly finished interior and practical open and angled lid with a frame, allowing easy access to the space of the bin. An aesthetic frame prevents a bin bag from slipping, and is also available in various colors, which facilitates waste segregation. The model is available in two sizes to fit a variety of spaces.

Prostokątny model z gładko wykończonym wnętrzem i praktyczną, profilowaną pokrywą z ramką umożliwiającą łatwy dostęp do przestrzeni kosza. Estetyczna ramka zapewnia stabilne zamocowanie worka, a dodatkowo występuje w różnych kolorach, co ułatwia segregację odpadów. Model jest dostępny w dwóch rozmiarach, dzięki czemu pasuje do różnych przestrzeni.



<b>compacta Q</b>	<b>NSBO25</b>	<b>NSBO45</b>
size [ l x w x h ]	296 x 264 x 526 mm	394 x 298 x 612 mm
volume	25 L	45 L
packaging	i	i
pallet quantity	i	i
pallet height	i	i
colour	<span style="display: inline-block; width: 10px; height: 10px; background-color: yellow; border-radius: 50%;"></span> 1215C <span style="display: inline-block; width: 10px; height: 10px; background-color: grey; border-radius: 50%;"></span> WG5C <span style="display: inline-block; width: 10px; height: 10px; background-color: lightblue; border-radius: 50%;"></span> 2717C <span style="display: inline-block; width: 10px; height: 10px; background-color: teal; border-radius: 50%;"></span> 5575C <span style="display: inline-block; width: 10px; height: 10px; background-color: darkgrey; border-radius: 50%;"></span> 429U	<span style="display: inline-block; width: 10px; height: 10px; background-color: yellow; border-radius: 50%;"></span> 1215C <span style="display: inline-block; width: 10px; height: 10px; background-color: grey; border-radius: 50%;"></span> WG5C <span style="display: inline-block; width: 10px; height: 10px; background-color: lightblue; border-radius: 50%;"></span> 2717C <span style="display: inline-block; width: 10px; height: 10px; background-color: teal; border-radius: 50%;"></span> 5575C <span style="display: inline-block; width: 10px; height: 10px; background-color: darkgrey; border-radius: 50%;"></span> 429U



waste bin

# Compacta Q set



compacta Q set	NSBO25S3	NSBO25S4	NSBO45S3	NSBO45S4
size [ l x w x h ]	296 x 264 x 630 mm	296 x 264 x 690 mm	394 x 298 x ... mm	394 x 298 x ... mm
volume	3 x 25 L	4 x 25 L	3 x 45 L	4 x 45 L
packaging	set of 3	set of 4	set of 3	set of 4
pallet quantity	i	i	i	i
pallet height	i	i	i	i
colour	120C 2383C  362C	120C  7589C 2383C  362C	120C 2383C  362C	120C  7589C 2383C  362C

heat-shrinkable foil protection

# Compacta R

A round bin with smoothly finished interior and practical open and angled lid with a frame, allowing easy access to the space of the bin. An aesthetic frame prevents a bin bag from slipping, and is also available in various colors, which facilitates waste segregation. The model is available in two sizes to fit a variety of spaces.

Okrągły model z gładko wykończonym wnętrzem i praktyczną, profilowaną pokrywą z ramką umożliwiającą łatwy dostęp do przestrzeni kosza. Estetyczna ramka zapewnia stabilne zamocowanie worka, a dodatkowo występuje w różnych kolorach, co ułatwia segregację odpadów. Model jest dostępny w dwóch rozmiarach, dzięki czemu pasuje do różnych przestrzeni.



compacta R	NRBO25	NRBO45
size [ l x w x h ]	318 x 318 x 525 mm	394 x 394 x 650 mm
volume	25 L	45 L
packaging	i	i
pallet quantity	i	i
pallet height	i	i
colour	<span style="color: yellow;">●</span> 1215C <span style="color: brown;">●</span> WG5C <span style="color: blue;">●</span> 2717C <span style="color: green;">●</span> 5575C <span style="color: grey;">●</span> 429U	<span style="color: yellow;">●</span> 1215C <span style="color: brown;">●</span> WG5C <span style="color: blue;">●</span> 2717C <span style="color: green;">●</span> 5575C <span style="color: grey;">●</span> 429U





waste bin

# Compacta R set



compacta R set	NRBO25S3	NRBO25S4	NRBO45S3	NRBO45S4
size [ l x w x h ]	318 x 318 x 680 mm	318 x 318 x 765 mm	394 x 394 x 825 mm	394 x 394 x 905 mm
volume	3 x 25 L	4 x 25 L	3 x 45 L	4 x 45 L
packaging	set of 3	set of 4	set of 3	set of 4
pallet quantity	i	i	i	i
pallet height	i	i	i	i
colour	120C 2383C  362C	120C  7589C 2383C  362C	120C 2383C  362C	120C  7589C 2383C  362C

heat-shrinkable foil protection

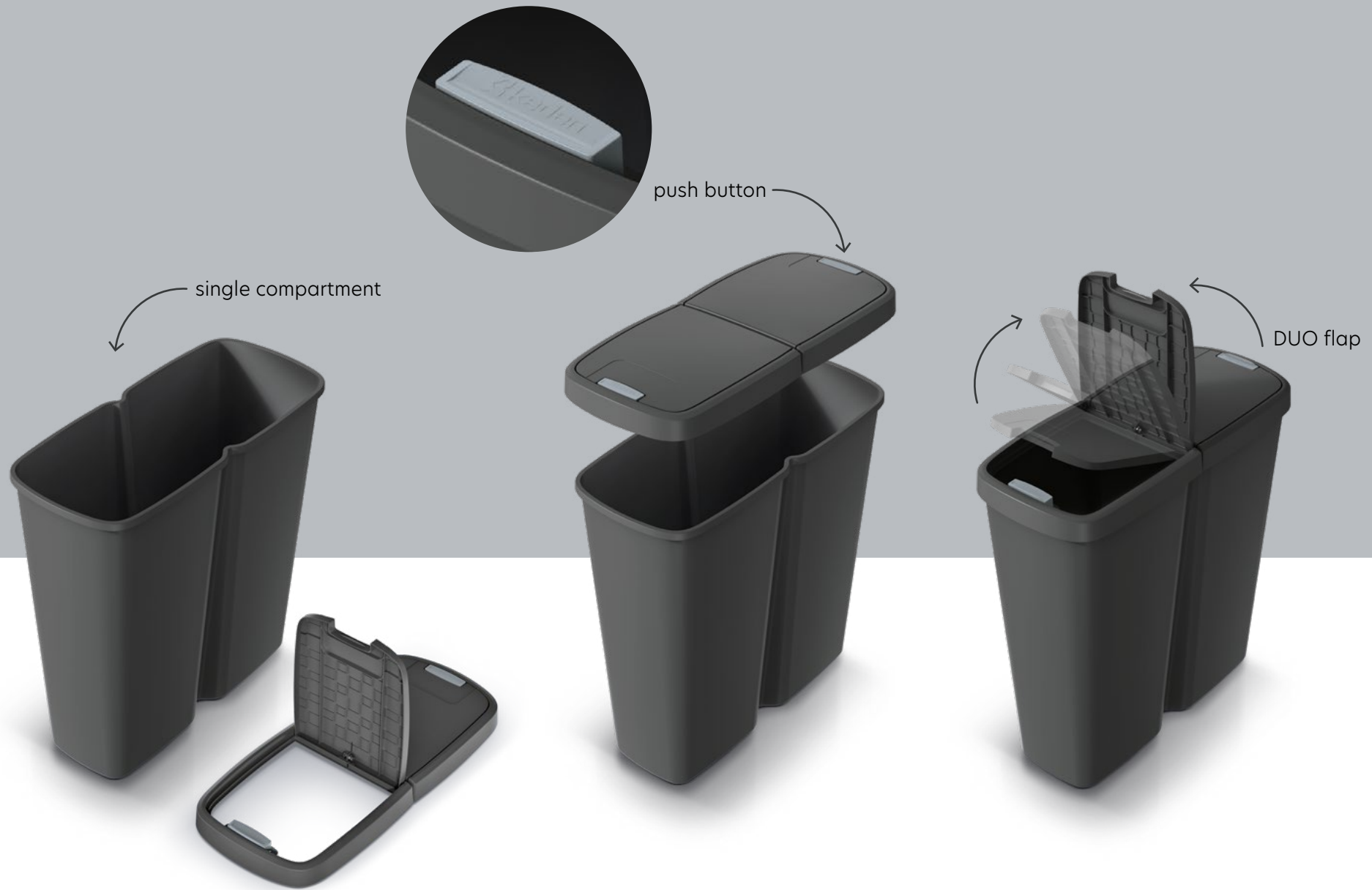



waste bin



# Compacta Q duo



Compacta duo is a single-compartment bin with two independent lids. Thanks to this, it can be used both for segregation or simply as a bin with access from two sides, which will be an ideal solution for office spaces. As in other Compacta models, stable frames hold the bin bags, and the lack of a partition wall also allows the use of one larger bin bag.

Compacta Q duo to jednokomorowy model wyposażony w dwie niezależne pokrywy. Dzięki temu może zarówno służyć segregacji, jak i być koszem z dostępem z dwóch stron, co bardzo dobrze sprawdzi się w przestrzeniach biurowych. Tak jak w innych modelach Compacta, stabilne ramki mocują worki na odpady, a brak ścianki rozdzielającej pozwala również na użycie jednego, większego worka.



compacta Q duo	NDAB45	NDAB50
size [ l x w x h ]	485 x 285 x 510 mm	545 x 245 x 565 mm
volume	45 L	50 L
packaging	4 / -	4 / -
pallet quantity	72	64
pallet height	~1,86 m	~1,90 m
colour	● S411* 	● S411* 

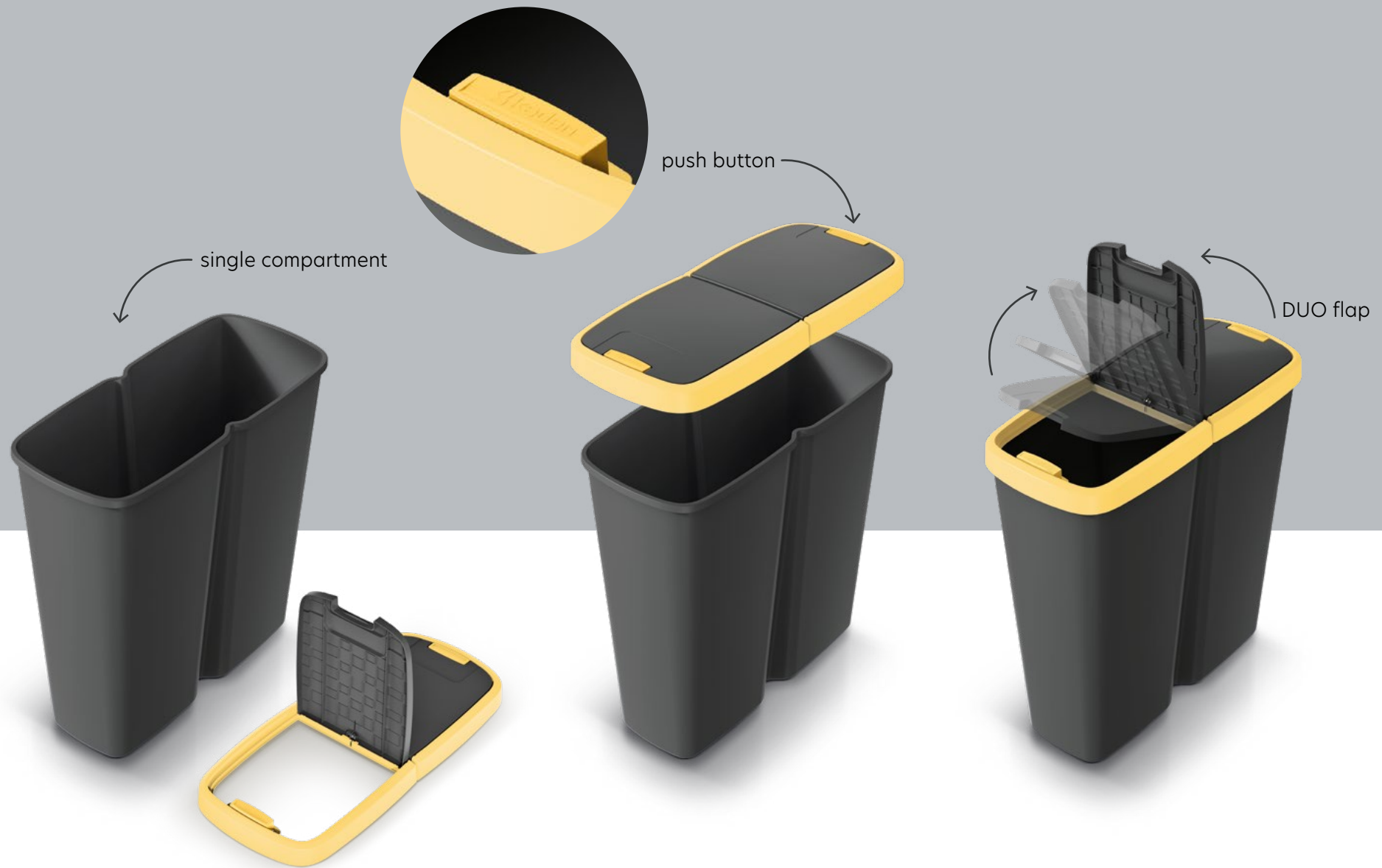

waste bin

# Compacta Q duo



Compacta duo is a single-compartment bin with two independent lids. Thanks to this, it can be used both for segregation or simply as a bin with access from two sides, which will be an ideal solution for office spaces. As in other Compacta models, stable frames hold the bin bags, and the lack of a partition wall also allows the use of one larger bin bag.

Compacta Q duo to jednokomorowy model wyposażony w dwie niezależne pokrywy. Dzięki temu może zarówno służyć segregacji, jak i być koszem z dostępem z dwóch stron, co bardzo dobrze sprawdzi się w przestrzeniach biurowych. Tak jak w innych modelach Compacta, stabilne ramki mocują worki na odpady, a brak ścianki rozdzielającej pozwala również na użycie jednego, większego worka.



compacta Q duo	NDAB45	NDAB50
size [ l x w x h ]	485 x 285 x 510 mm	545 x 245 x 565 mm
volume	45 L	50 L
packaging	4 / -	4 / -
pallet quantity	72	64
pallet height	~1,86 m	~1,90 m
colour	<ul style="list-style-type: none"> <li><span style="display: inline-block; width: 10px; height: 10px; background-color: yellow; border-radius: 50%; margin-right: 5px;"></span> 1215C/427C</li> <li><span style="display: inline-block; width: 10px; height: 10px; background-color: brown; border-radius: 50%; margin-right: 5px;"></span> WG5C/427C</li> <li><span style="display: inline-block; width: 10px; height: 10px; background-color: lightblue; border-radius: 50%; margin-right: 5px;"></span> 2717C/427C</li> <li><span style="display: inline-block; width: 10px; height: 10px; background-color: green; border-radius: 50%; margin-right: 5px;"></span> 5575C/427C</li> <li><span style="display: inline-block; width: 10px; height: 10px; background-color: grey; border-radius: 50%; margin-right: 5px;"></span> 429U/427C</li> </ul>	<ul style="list-style-type: none"> <li><span style="display: inline-block; width: 10px; height: 10px; background-color: yellow; border-radius: 50%; margin-right: 5px;"></span> 1215C/427C</li> <li><span style="display: inline-block; width: 10px; height: 10px; background-color: brown; border-radius: 50%; margin-right: 5px;"></span> WG5C/427C</li> <li><span style="display: inline-block; width: 10px; height: 10px; background-color: lightblue; border-radius: 50%; margin-right: 5px;"></span> 2717C/427C</li> <li><span style="display: inline-block; width: 10px; height: 10px; background-color: green; border-radius: 50%; margin-right: 5px;"></span> 5575C/427C</li> <li><span style="display: inline-block; width: 10px; height: 10px; background-color: grey; border-radius: 50%; margin-right: 5px;"></span> 429U/427C</li> </ul>
	<ul style="list-style-type: none"> <li><span style="display: inline-block; width: 10px; height: 10px; background-color: yellow; border-radius: 50%; margin-right: 5px;"></span> 1215C/S411</li> <li><span style="display: inline-block; width: 10px; height: 10px; background-color: brown; border-radius: 50%; margin-right: 5px;"></span> WG5C/S411</li> <li><span style="display: inline-block; width: 10px; height: 10px; background-color: lightblue; border-radius: 50%; margin-right: 5px;"></span> 2717C/S411</li> <li><span style="display: inline-block; width: 10px; height: 10px; background-color: green; border-radius: 50%; margin-right: 5px;"></span> 5575C/S411</li> <li><span style="display: inline-block; width: 10px; height: 10px; background-color: grey; border-radius: 50%; margin-right: 5px;"></span> 429U/S411</li> </ul>	<ul style="list-style-type: none"> <li><span style="display: inline-block; width: 10px; height: 10px; background-color: yellow; border-radius: 50%; margin-right: 5px;"></span> 1215C/S411</li> <li><span style="display: inline-block; width: 10px; height: 10px; background-color: brown; border-radius: 50%; margin-right: 5px;"></span> WG5C/S411</li> <li><span style="display: inline-block; width: 10px; height: 10px; background-color: lightblue; border-radius: 50%; margin-right: 5px;"></span> 2717C/S411</li> <li><span style="display: inline-block; width: 10px; height: 10px; background-color: green; border-radius: 50%; margin-right: 5px;"></span> 5575C/S411</li> <li><span style="display: inline-block; width: 10px; height: 10px; background-color: grey; border-radius: 50%; margin-right: 5px;"></span> 429U/S411</li> </ul>



# Systema waste bin



Order in your surroundings means more space for you and your ideas



NKS12



NKS30



NKS30W2



NKS45W2



# Systema



Systema is a product line that has been especially designed for waste segregation. Their modular, regular form allows to arrange them in any configuration, adjusting them to the shape of a cabinet or drawer. In addition, most of the models come with a dedicated hanger that allows the container to be hung on a wall or door.

Systema to linia produktów, które zostały zaprojektowane specjalnie na potrzeby segregacji odpadów. Ich modułowa forma i regularne kształty sprawiają, że można je ustawić w dowolnej konfiguracji, dopasowując je do wymiarów szafki lub szuflady. Dodatkowo, większość z modeli jest wyposażona w dedykowany wieszak, pozwalający zawiesić pojemnik na ścianie czy drzwiach.

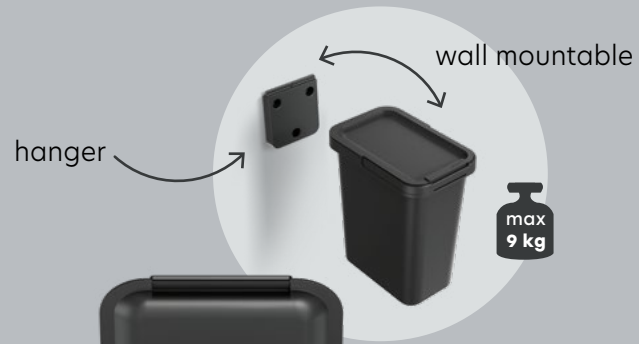

NKS12

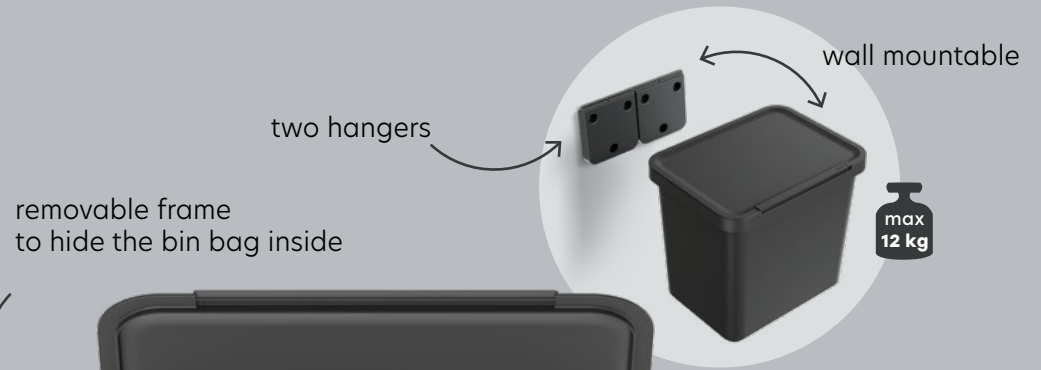

NKS30

removable leg base



waste bin

# Systema



The NKS12 and NKS30 models from the Systema line are available in two sizes, are made of recycled material and are the perfect solution for places with limited space. They have a fashionable, hinged lid and a functional frame, thanks to which the bin bag is firmly attached and does not change its position. Both variants are equipped with a wall hanger, and the NKS30 model has a removable leg base.

Modele NKS12 oraz NKS30 to sortowniki z linii Systema w dwóch rozmiarach, stworzone z materiału pozyskanego z recyklingu, które są idealnym rozwiązaniem dla miejsc o ograniczonej przestrzeni. Zostały wyposażone w designerską, uchylną pokrywę oraz funkcjonalną ramkę, dzięki której worek jest stabilnie umocowany i nie zmienia położenia. Oba warianty zostały wyposażone w wieszak naścienny, a model NKS30 posiada zdejmowaną podstawę z nóżkami.

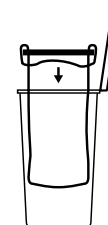

Systema

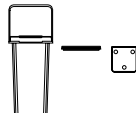
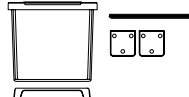

systema	NKS12	NKS30
size [ l x w x h ]	295 x 195 x 350 mm	390 x 295 x 410 mm
volume	12 L	29 L
packaging	1	1
pallet quantity	80	32
pallet height	~1,86 m	~1,76 m
colour	● S411* 	● S411* 
set contains		

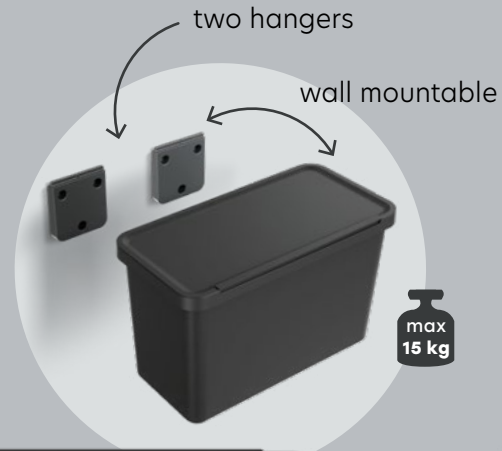
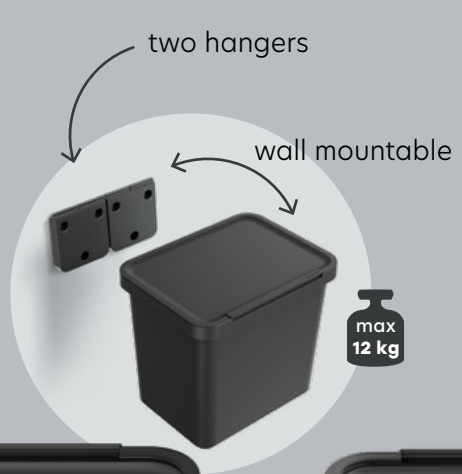

NKS30W2



NKS45W2

removable leg base



NKS45W3

stay open lid

waste bin



## Systema



The long sorter from the Systema line is made of recycled material. It is available in three sizes, so it can meet various requirements of users. Sorters have been equipped with 2 or 3 practical inserts, depending on users' needs. Each of them has solid ABS handles, removable leg base and a wall hanger.

Podłużny sortownik z linii Systema został stworzony z materiału pozyskanego z recyklingu. Występuje w trzech rozmiarach, dzięki czemu sprosta różnym wymaganiom użytkowników. Sortery zostały wyposażone w 2 lub 3 praktyczne wkłady z solidnymi uchwytami z tworzywa ABS, w kolorystyce ułatwiającej segregację. Każdy z nich posiada zdejmowaną podstawę nóg oraz wieszak ścienny.



systema	NKS30W2	NKS45W2	NKS45W3
size [ l x w x h ]	390 x 295 x 410 mm	570 x 295 x 410 mm	570 x 295 x 410 mm
volume	2 x 10 L	1 x 10 L + 1 X 23 L	3 x 10 L
packaging	1	1	1
pallet quantity	32	16	16
pallet height	~1,76	~1,76	~1,76
colour	● S411*	● S411*	● S411*
set contains			

easy sorting of household waste  
perfect organiser



NKS60W2



NKS60W3



NKS60W4

waste bin





## Systema



Sorters NKS60W2, NKS60W3, NKS60W4 from the Systema line are made of recycled material and come in three variants, with two, three or four inserts. Each of the variants has inserts with practical ABS handles and additional lids. The entire system can be placed on the floor, which is possible thanks to a removable leg base.

Sortowniki NKS60W2, NKS60W3, NKS60W4 z linii Systema zostały stworzone z materiału pozyskanego z recyklingu oraz występują w trzech wariantach, wyposażonych w kolejno w dwa, trzy lub cztery pojemniki. Każdy z wariantów posiada wkłady z praktycznymi uchwytami z tworzywa ABS i dodatkowe pokrywy. Cały system można postawić na podłodze, co umożliwia zdejmowaną podstawę z nóżkami.

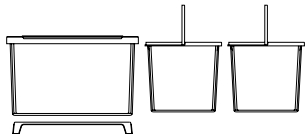
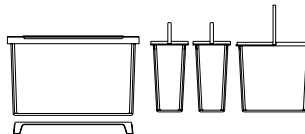
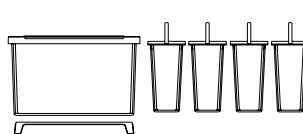

systema	NKS60W2	NKS60W3	NKS60W4
size [ l x w x h ]	565 x 390 x 410 mm	565 x 390 x 410 mm	565 x 390 x 410 mm
volume	2 x 23 L	1 x 23 + 2 x 10 L	4 x 10 L
packaging	1	1	1
pallet quantity	16	16	16
pallet height	~1,76	~1,76	~1,76
colour	● S411* 	● S411* 	● S411* 
set contains			

# waste bin

# Systema basic

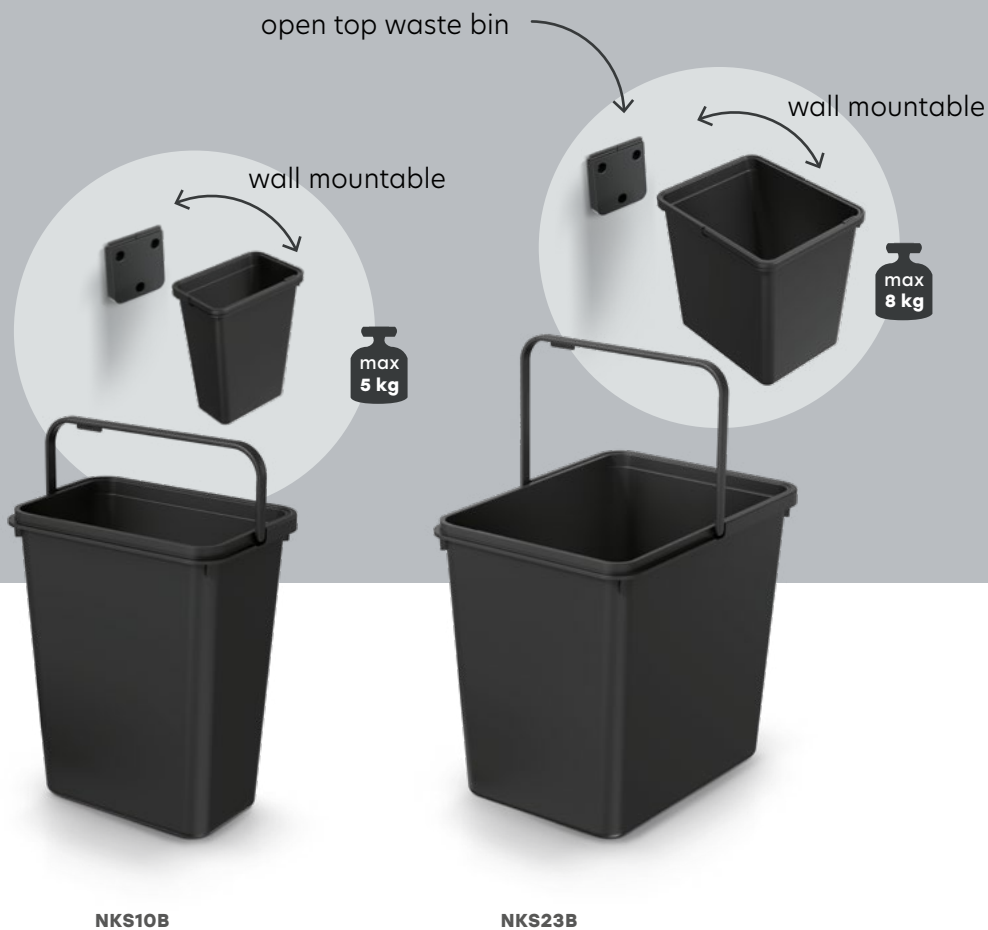

The Systema line sorter insert has a regular shape, so it can be positioned in any configuration, depending on the size of the main Systema bin. It has a durable ABS handle and is available in two sizes, ideally suited to the dimensions of the under-sink cabinet. By equipping it with additional NKSH wall hangers, you can hang it on the wall, and by placing it in drawers, you can create your own segregation system.

Wkład do sortowników z linii Systema posiada regularne kształty, dzięki czemu można go ustawić w dowolnej konfiguracji, zależnie od rozmiaru głównego kosza. Jest wyposażony w wytrzymały uchwyt z ABS i występuje w dwóch rozmiarach, idealnie dopasowanych do wymiarów szafki pod zlewozmywakiem. Wyposażając go w dodatkowy wieszak naścienny NKSH, można zawiesić go na ścianie, a ustawiając go w szufladach stworzyć swój własny system segregacji.



systema basic	NKS10B	NKS23B	NKSH
size [ l x w x h ]	266 x 178 x 327 mm	360 x 266 x 327 mm	145 x 27 x 160 mm
volume	10 L	23 L	-
packaging	1	1	1
pallet quantity	1	1	1
pallet height	~1	~1	~1
colour	● S411*	● S411*	● S411*





Systema

# Systema



waste bin





NKS10W



NKS23W

removable lid

systema	NKS10W	NKS23W
size [ l x w x h ]	266 x 178 x 327 mm	360 x 266 x 327 mm
volume	10 L	23 L
packaging	4 / -	4 / -
pallet quantity	336	144
pallet height	~1,83 m	~1,83 m
colour	● S411* 	● S411* 

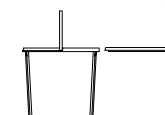

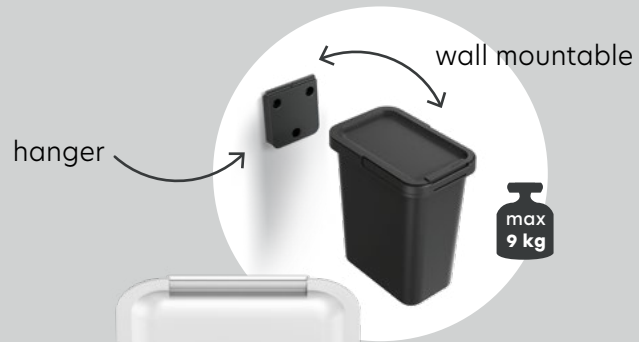

NKS12

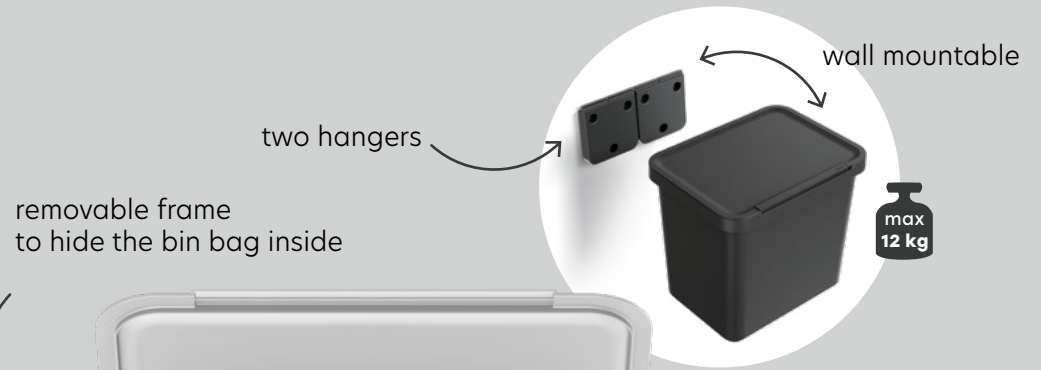

NKS30

waste bin

## Systema



Systema

The NKS12 and NKS30 models from the Systema line are available in two sizes and are the perfect solution for places with limited space. They have a fashionable, hinged lid and a functional frame, thanks to which the bin bag is firmly attached and does not change its position. Both variants are equipped with a wall hanger, and the NKS30 model has a removable leg base.

Modele NKS12 oraz NKS30 to sortowniki z linii Systema w dwóch rozmiarach, które są idealnym rozwiązaniem dla miejsc o ograniczonej przestrzeni. Zostały wyposażone w designerską, uchylną pokrywę oraz funkcjonalną ramkę, dzięki której worek jest stabilnie umocowany i nie zmienia położenia. Oba warianty zostały wyposażone w wieszak naścienny, a model NKS30 posiada zdejmowaną podstawę z nóżkami.

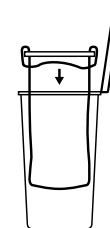

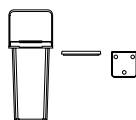
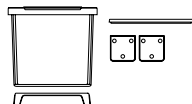
systema	NKS12	NKS30
size [ l x w x h ]	295 x 195 x 350 mm	390 x 295 x 410 mm
volume	12 L	29 L
packaging	1	1
pallet quantity	80	32
pallet height	~1,86 m	~1,76 m
colour	● 427C ● 429U	● 427C ● 429U
	set contains	set contains
		



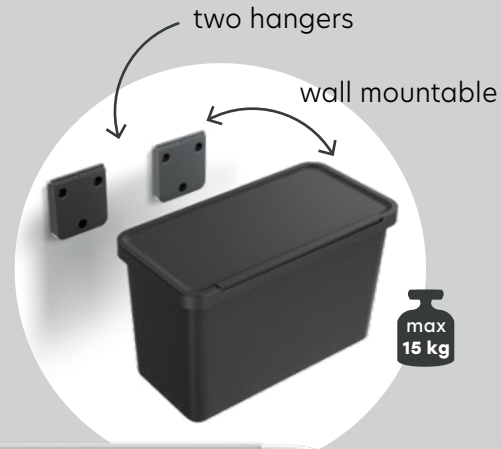
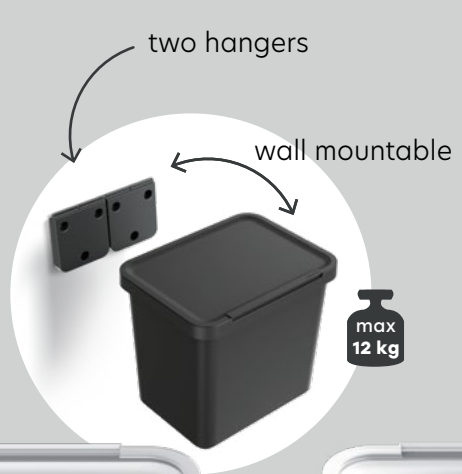

**NKS30W2**



**NKS45W2**

removable leg base



**NKS45W3**

# waste bin

# Systema



Systema

The long sorter from the Systema line is available in three sizes and two fashionable colour variants, so it can meet various requirements of users. Sorters have been equipped with 2 or 3 practical inserts, depending on users' needs. Each of them has solid ABS handles, removable leg base and a wall hanger.

Podłużny sortownik z linii Systema dostępny jest w trzech rozmiarach oraz dwóch modnych wariantach kolorystycznych, dzięki czemu sprosta różnym wymaganiom użytkowników. Sortery zostały wyposażone w 2 lub 3 praktyczne wkłady z solidnymi uchwytami z tworzywa ABS, w kolorystyce ułatwiającej segregację. Każdy z nich posiada zdejmowaną podstawę nóg oraz wieszak ścienny.



systema	NKS30W2	NKS45W2	NKS45W3
size [ l x w x h ]	390 x 295 x 410 mm	570 x 295 x 410 mm	570 x 295 x 410 mm
volume	2 x 10 L	1 x 10 L + 1 x 23 L	3 x 10 L
packaging	1	1	1
pallet quantity	32	16	16
pallet height	~1,76 m	~1,76 m	~1,76 m
colour	● 427C ● 429U	● 427C ● 429U	● 427C ● 429U
	set contains	set contains	set contains

easy sorting of household waste  
perfect organiser

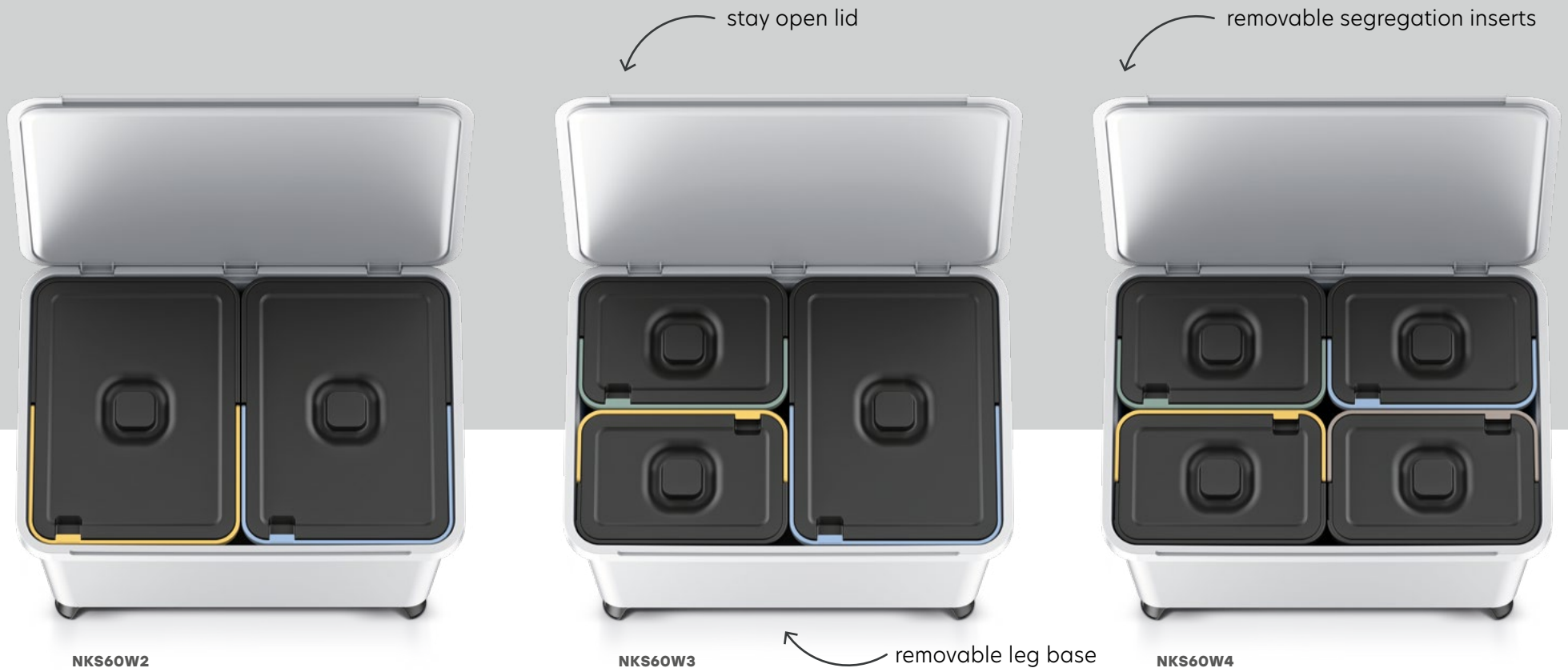

# waste bin



# Systema



Sorters NKS60W2, NKS60W3, NKS60W4 from the Systema line come in three variants, with two, three or four inserts and two fashionable colours. Each of the variants has inserts with practical ABS handles and additional lids. The entire system can be placed on the floor, which is possible thanks to a removable leg base.

Sortowniki NKS60W2, NKS60W3, NKS60W4 z linii Systema występują w trzech wariantach, wyposażonych w kolejno w dwa, trzy lub cztery pojemniki oraz dwóch designerskich kolorach. Każdy z wariantów posiada wkłady z praktycznymi uchwytami z tworzywa ABS i dodatkowe pokrywy. Cały system można postawić na podłodze, co umożliwia zdemontowana podstawa z nóżkami.



systema	NKS60W2	NKS60W3	NKS60W4
size [ l x w x h ]	565 x 390 x 410 mm	565 x 390 x 410 mm	565 x 390 x 410 mm
volume	2 x 23 L	1 x 23 L + 2 x 10 L	4 x 10 L
packaging	1	1	1
pallet quantity	16	16	16
pallet height	~1,76 m	~1,76 m	~1,76 m
colour	● 427C ● 429U	● 427C ● 429U	● 427C ● 429U
	set contains	set contains	set contains

easy sorting of household waste  
perfect organiser  
modular construction  
stiffening crease







waste bin

# Sortibox



Sortibox is available in sets of three, four or five bins with a flap on the front of the lid. This model has a special embossing in the lids and recesses in their bodies, thanks to which they can be easily arranged in rows or stable posts that can be stacked regardless of their size. This makes them perfect for places with limited space and coloured stickers can be stuck on the lids indicating the types of sorted waste.

Sortibox jest dostępny w zestawach trzech, czterech lub pięciu koszy, które posiadają klapkę z przodu pokrywy. Model posiada specjalne wytłoczenia w pokrywach oraz wgłębienia w korpusach, dzięki którym z łatwością można zestawić je w szeregi lub stabilne słupki, które można piętrzyć niezależnie od rozmiaru. To sprawia, że doskonale nadają się do miejsc o ograniczonej przestrzeni, a kolorowe naklejki, które można przykleić na pokrywach wskazują rodzaje sortowanych odpadów.



sortibox	ISWB20S3	ISWB20S4	ISWB20S5
size [ l x w x h ]	395 x 232 x 460 mm	395 x 232 x 525 mm	395 x 232 x 590 mm
volume	3 x 20 L	4 x 20 L	5 x 20 L
packaging	set of 3	set of 4	set of 5
pallet quantity	37	30	30
pallet height	~1,92 m	~1,73 m	~1,92 m
colour	○ S449 ● 405U ● S411*	○ S449 ● 405U ● S411*	● 405U ● S411*
	set of 3 x 20 L	set of 4 x 20 L	set of 5 x 20 L

each pack contains a set of color stickers for easy waste sorting



Sortibox

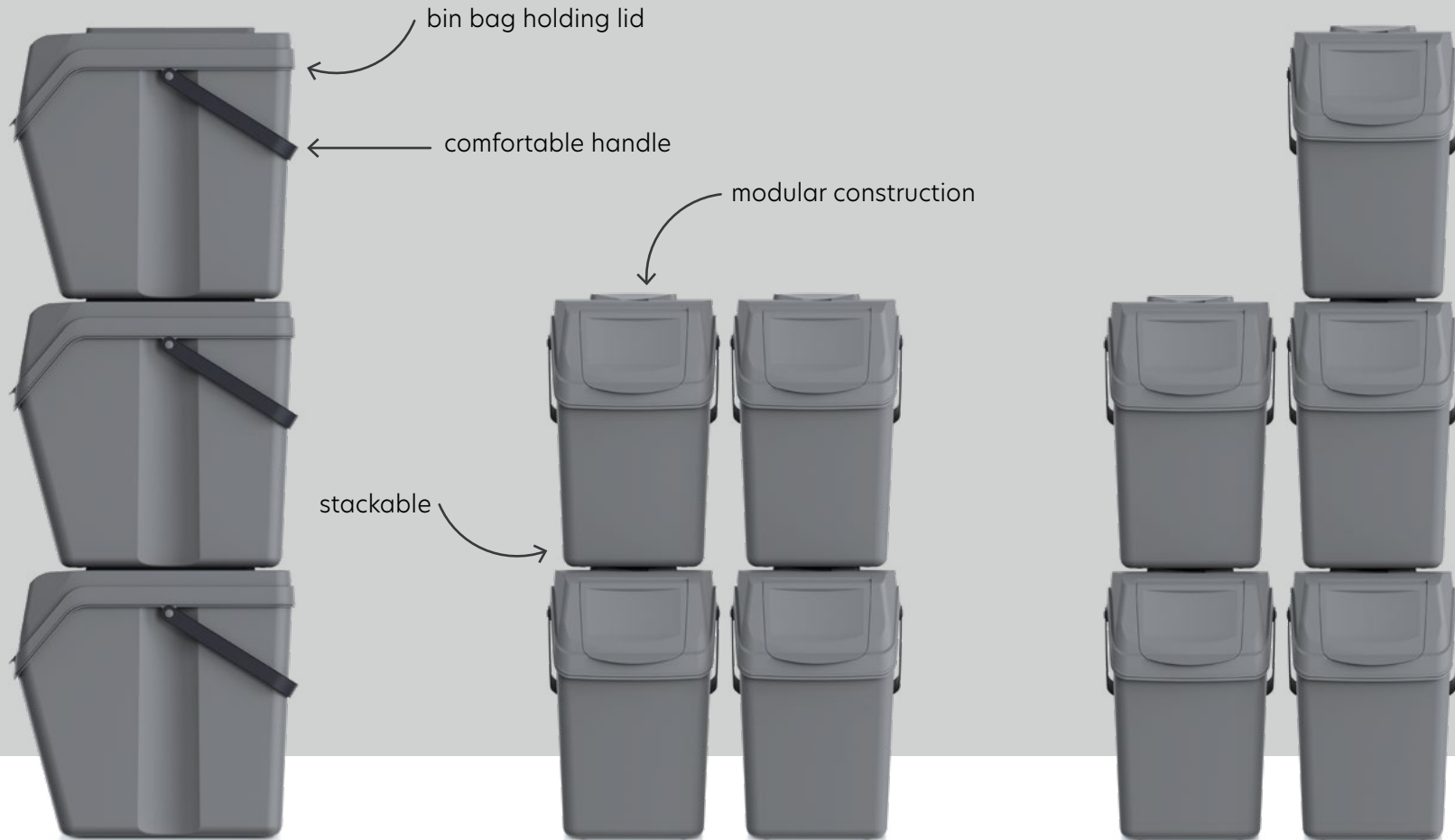

set of 3 x 25 L

TOTAL  
**75L**  
CAPACITY

set of 4 x 25 L

TOTAL  
**100L**  
CAPACITY

set of 5 x 25 L

TOTAL  
**125L**  
CAPACITY

waste bin



## Sortibox



Sortibox is available in single units or in sets of three, four or five bins. This model has a flap on the front of the lid and a functional handle. Special embossing in the lids and recesses in their bodies, allows them to be easily arranged in rows or stable posts that can be stacked regardless of their size. Coloured stickers can be stuck on the lids indicating the types of sorted waste.

Sortibox jest dostępny w pojedynczych sztukach lub w zestawach trzech, czterech lub pięciu koszy. Model posiada kłapkę z przodu pokrywy oraz funkcjonalną rączkę. Specjalne wytłoczenia w pokrywach oraz wgłębienia w korpusach, umożliwiają zestawienie je w szeregi lub stabilne słupki, które można piętrzyć niezależnie od rozmiaru. Kolorowe naklejki w zestawie można przykleić na pokrywach wskazując rodzaje sortowanych odpadów.



Sortibox



sortibox	ISWB25	ISWB25S3	ISWB25S4	ISWB25S5
size [ l x w x h ]	402 x 240 x 377 mm	402 x 240 x 505 mm	402 x 240 x 570 mm	402 x 240 x 640 mm
volume	25 L	3 x 25 L	4 x 25 L	5 x 25 L
packaging	4 / -	set of 3	set of 4	set of 5
pallet quantity	120	34	30	25
pallet height	~1,86 m	~1,90 m	~1,86 m	~1,86 m
colour	○ S449 ● 405U ● S411*	○ S449 ● 405U ● S411*	○ S449 ● 405U ● S411*	● 405U ● S411*

each pack contains a set of color stickers for easy waste sorting

easy sorting of household waste  
perfect organiser  
modular construction

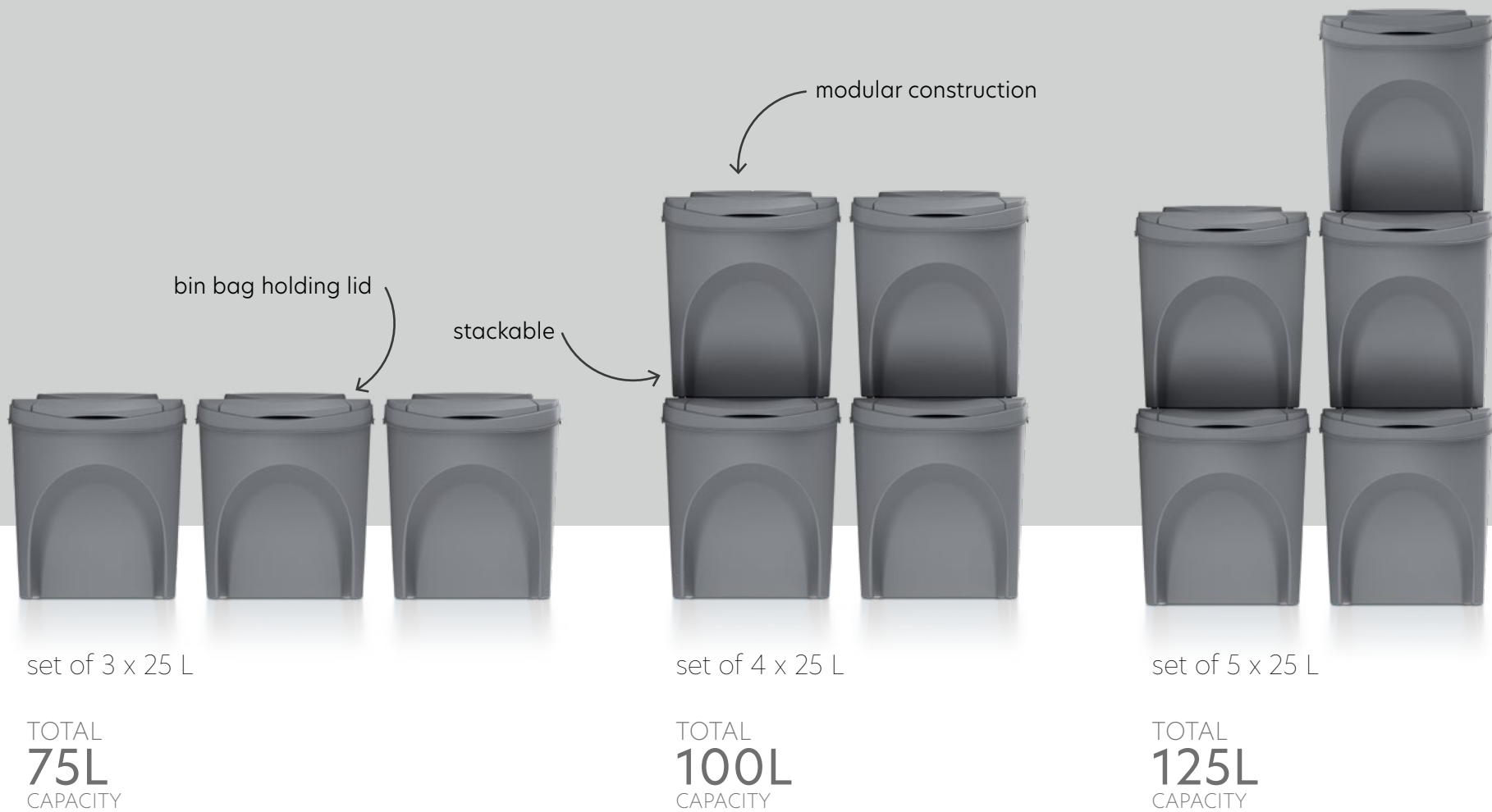



waste bin

# Sortibox



Sortibox is available in sets of three, four or five 25 litre bins with a flap on the top of the lid. This model has a special embossing in the lids and recesses in their bodies, thanks to which they can be easily arranged in rows or stable posts that can be stacked regardless of their size. This makes them perfect for places with limited space and coloured stickers can be stuck on the lids indicating the types of sorted waste.

Sortibox jest dostępny w zestawach trzech, czterech lub pięciu 25 litrowych koszy, które posiadają klapkę na górze pokrywy. Model posiada specjalne wytłoczenia w pokrywach oraz wgłębienia w korpusach, dzięki którym z łatwością można zestawić je w szeregi lub stabilne słupki, które można piętrzyć niezależnie od rozmiaru. To sprawia, że doskonale nadają się do miejsc o ograniczonej przestrzeni, a kolorowe naklejki, które można przykleić na pokrywach wskazują rodzaje sortowanych odpadów.



sortibox	IKWB25S3	IKWB25S4	IKWB25S5
size [ l x w x h ]	392 x 293 x 456 mm	392 x 293 x 518 mm	392 x 293 x 590 mm
volume	3 x 25 L	4 x 25 L	5 x 25 L
packaging	set of 3	set of 4	set of 5
pallet quantity	30	24	24
pallet height	~1,92 m	~1,73 m	~1,92 m
colour	○ S449 ● 405U ● S411*	○ S449 ● 405U ● S411*	● 405U ● S411*

each pack contains a set of color stickers for easy waste sorting

easy sorting of household waste  
perfect organiser  
modular construction

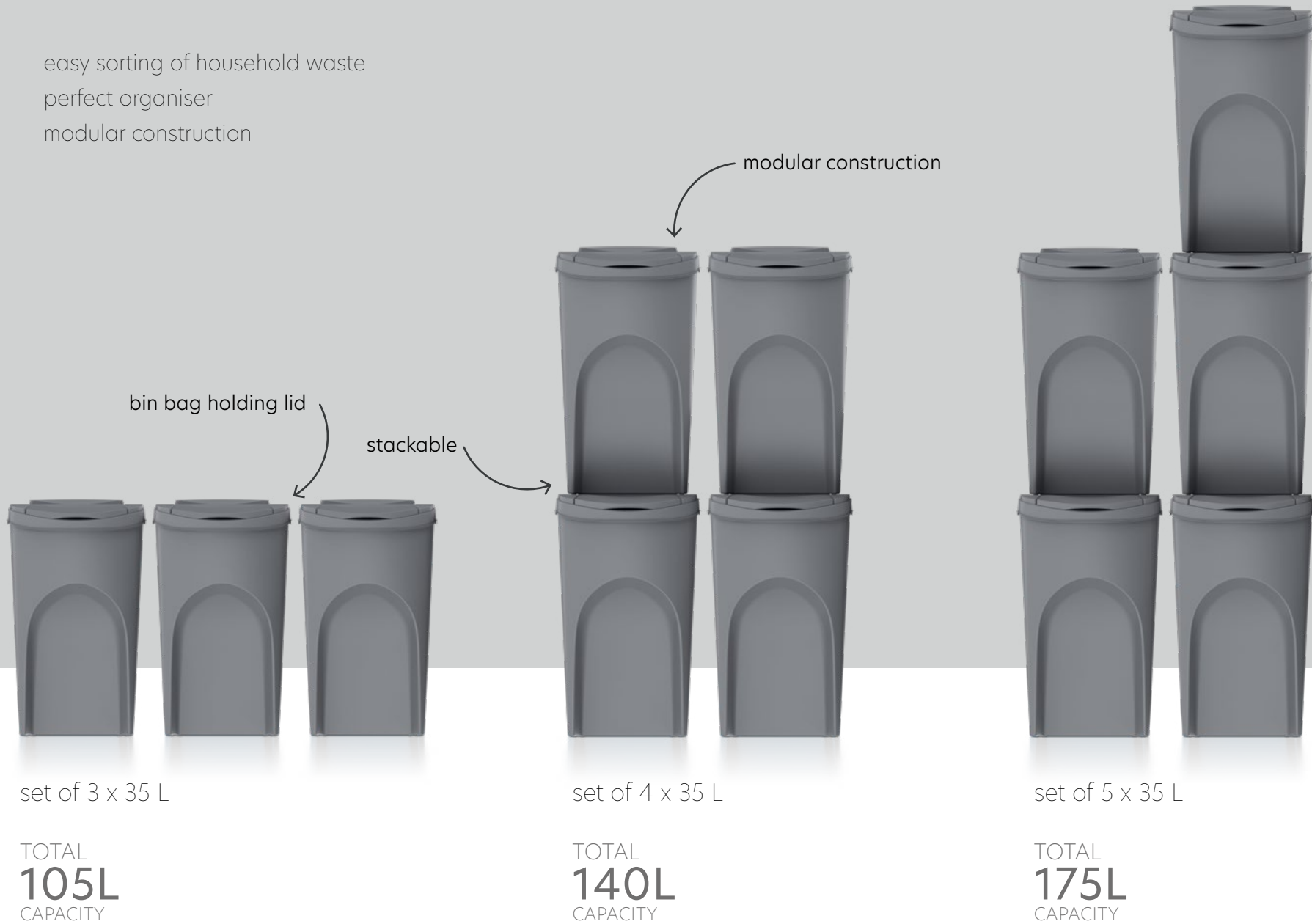

waste bin



## Sortibox



Sortibox is available in sets of three, four or five 35 litre bins with a flap on the top of the lid. This model has a special embossing in the lids and recesses in their bodies, thanks to which they can be easily arranged in rows or stable posts that can be stacked regardless of their size. Coloured stickers can be stuck on the lids indicating the types of sorted waste.

Sortibox jest dostępny w zestawach trzech, czterech lub pięciu 35 litrowych koszy, które posiadają klapkę na górze pokrywy. Model posiada specjalne wytłoczenia w pokrywach oraz wgłębienia w korpusach, dzięki którym z łatwością można zestawić je w szeregi lub stabilne słupki, które można piętrzyć niezależnie od rozmiaru. Kolorowe naklejki w zestawie można przykleić na pokrywach wskazując rodzaje sortowanych odpadów.



sortibox	IKWB35S3	IKWB35S4	IKWB35S5
size [ l x w x h ]	392 x 293 x 620 mm	392 x 293 x 680 mm	392 x 293 x 755 mm
volume	3 x 35 L	4 x 35 L	5 x 35 L
packaging	set of 3	set of 4	set of 5
pallet quantity	20	20	19
pallet height	~1,76 m	~1,90 m	~1,95 m
colour	○ S449 ● 405U ● S411*	○ S449 ● 405U ● S411*	● 405U ● S411*

each pack contains a set of color stickers for easy waste sorting

easy sorting of household waste  
perfect organiser  
modular construction

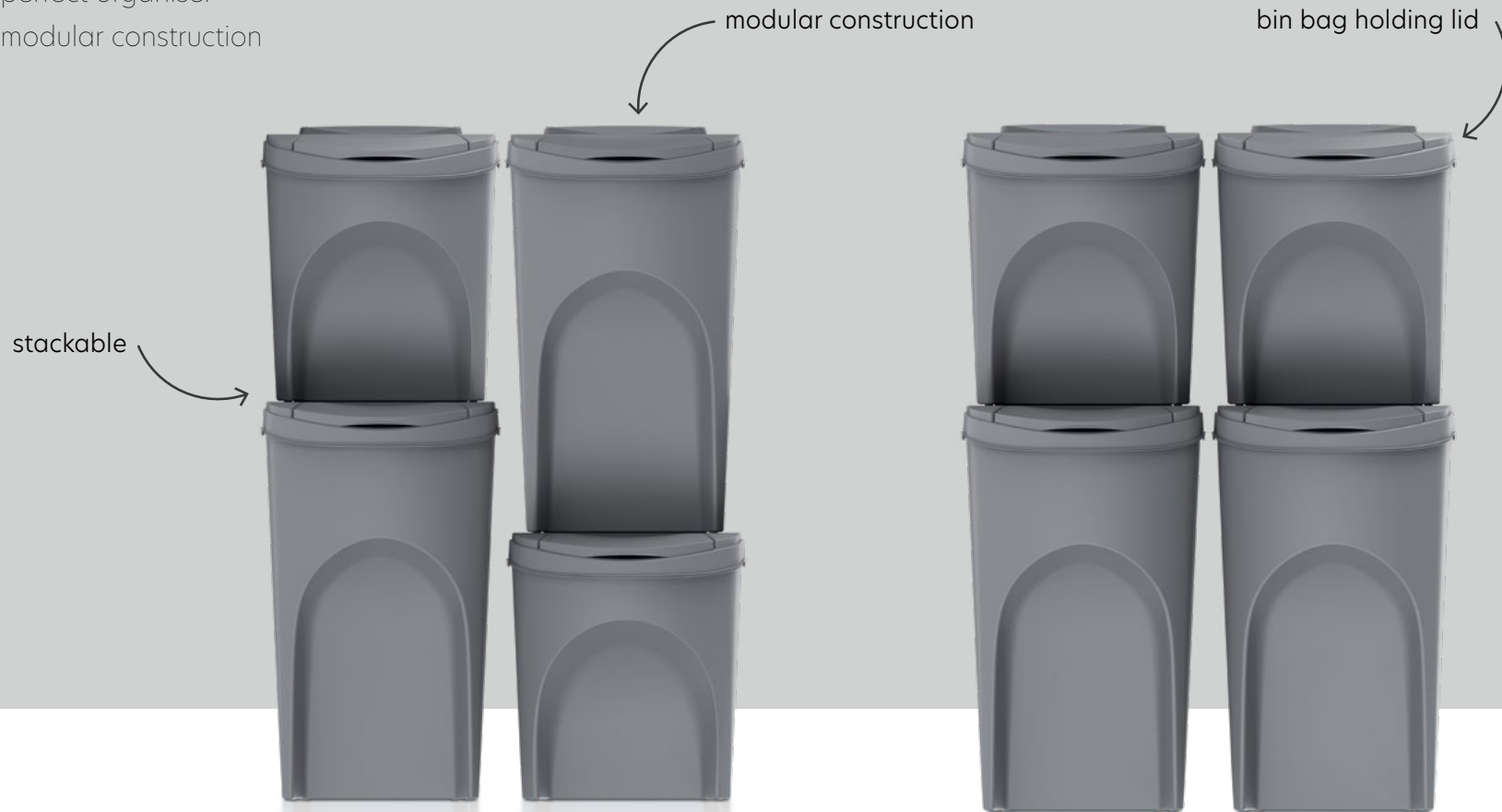

set of 2 x 25 L + 2 x 35L

TOTAL  
**120L**  
CAPACITY

set of 2 x 25 L + 2 x 35L

TOTAL  
**120L**  
CAPACITY





waste bin



## Sortibox



Sortibox IKWBMS4 is a set of two 25 litre and two 35 litre bins with a flap on the top of the lid. This model has a special embossing in the lids and recesses in their bodies, thanks to which they can be easily arranged in rows or stable posts that can be stacked regardless of their size. This makes them perfect for places with limited space and coloured stickers can be stuck on the lids indicating the types of sorted waste.

Sortibox IKWBMS4 to zestaw dwóch 25 litrowych oraz dwóch 35 litrowych koszy, które posiadają klapkę na górze pokrywy. Model posiada specjalne wytłoczenia w pokrywach oraz wgłębienia w korpusach, dzięki którym z łatwością można zestawiać je w szeregi lub stabilne słupki, które można piętrzyć niezależnie od rozmiaru. To sprawia, że doskonale nadają się do miejsc o ograniczonej przestrzeni, a kolorowe naklejki które można przykleić na pokrywach wskazują rodzaje sortowanych odpadów.



sortibox	IKWBMS4
size [ l x w x h ]	392 x 293 x 670 mm
volume	2 x 25 L + 2 x 35 L
packaging	set of 4
pallet quantity	20
pallet height	~1,87 m
colour	<input type="radio"/> S449 <input type="radio"/> 405U <input checked="" type="radio"/> S411*

each pack contains a set of color stickers for easy waste sorting



set of 3 x 25 L

TOTAL  
**75L**  
CAPACITY

set of 4 x 25 L

TOTAL  
**100L**  
CAPACITY

waste bin

# eco WOOD COLLECTION



## Sortibox ECO Wood

Sortibox from the ECO Wood Collection is available in sets of three or four 25 litre bins with a flap on the top of the lid. Products from the ECO Wood Collection contain up to 33% of natural wood, which results in easier biodegradability. This model has a special embossing in the lids and recesses in their bodies, thanks to which they can be easily arranged in rows or stable posts. Coloured stickers can be stuck on the lids indicating the types of sorted waste.

Sortibox z kolekcji ECO Wood jest dostępny w zestawach trzech lub czterech 25 litrowych koszy, które posiadają klapkę na górze pokrywy. Produkty z kolekcji ECO Wood zawierają aż 33% naturalnego drewna, co zapewnia łatwiejszą biodegradację. Model posiada specjalne wytłoczenia w pokrywach oraz wgłębienia w korpusach, dzięki którym z łatwością można zestawić je w szeregi lub stabilne słupki. Kolorowe naklejki w zestawie można przykleić na pokrywach wskazując rodzaje sortowanych odpadów.



Sortibox



sortibox	IKWB25S3W	IKWB25S4W
size [ l x w x h ]	392 x 293 x 456 mm	392 x 293 x 518 mm
volume	3 x 25 L	4 x 25 L
packaging	set of 3	set of 4
pallet quantity	30	24
pallet height	~1,92 m	~1,73 m
colour	4665W  S433W	4665W  S433W

each pack contains a set of color stickers for easy waste sorting

The technological process may affect the colour of the product.

easier biodegradability



← fully-opening lid with a lock

↖ self-assembly wheels

→ durable wheels assembled

NBWB90

90L  
CAPACITY

95L  
CAPACITY

110L  
CAPACITY

waste bin

# Wheeler



Wheeler is a mobile bin equipped with wheels and a handle for transportation, thanks to which it can be always where it is needed. Its tight lid isolates unpleasant smells, and a latch in the lid prevents it from being opened by the wind. The smoothly finished interior makes it easy to clean. The model is available in three sizes, so it meets the individual needs of the user.

Wheeler to mobilny kosz wyposażony w kółka i rączkę do transportu, dzięki którym może być zawsze tam, gdzie jest potrzebny. Jego szczelna pokrywa izoluje nieprzyjemne zapachy, a zatrzask w pokrywie zabezpiecza ją przed otwieraniem podczas wiatru. Gładko wykończone wnętrze ułatwia jego czyszczenie. Model występuje w trzech rozmiarach, dzięki czemu odpowiada na indywidualne potrzeby użytkownika.



wheeler	NBWB90	NBWB95	NBWB110
size [ l x w x h ]	583 x 394 x 783 mm	540 x 496 x 762 mm	540 x 496 x 852 mm
volume	90 L	95 L	110 L
packaging	1	1	1
pallet quantity	24	16	14
pallet height	~1,87 m	~1,85 m	~1,80 m
colour	<span style="color: yellow;">●</span> 120C <span style="color: brown;">●</span> 7589C <span style="color: blue;">●</span> 2383C <span style="color: green;">●</span> 362C <span style="color: black;">●</span> S411*	<span style="color: yellow;">●</span> 120C <span style="color: brown;">●</span> 7589C <span style="color: blue;">●</span> 2383C <span style="color: green;">●</span> 362C <span style="color: black;">●</span> S411*	<span style="color: yellow;">●</span> 120C <span style="color: brown;">●</span> 7589C <span style="color: blue;">●</span> 2383C <span style="color: green;">●</span> 362C <span style="color: black;">●</span> S411*



NBWB95  
NBWB110

easy sorting of household waste  
perfect organiser

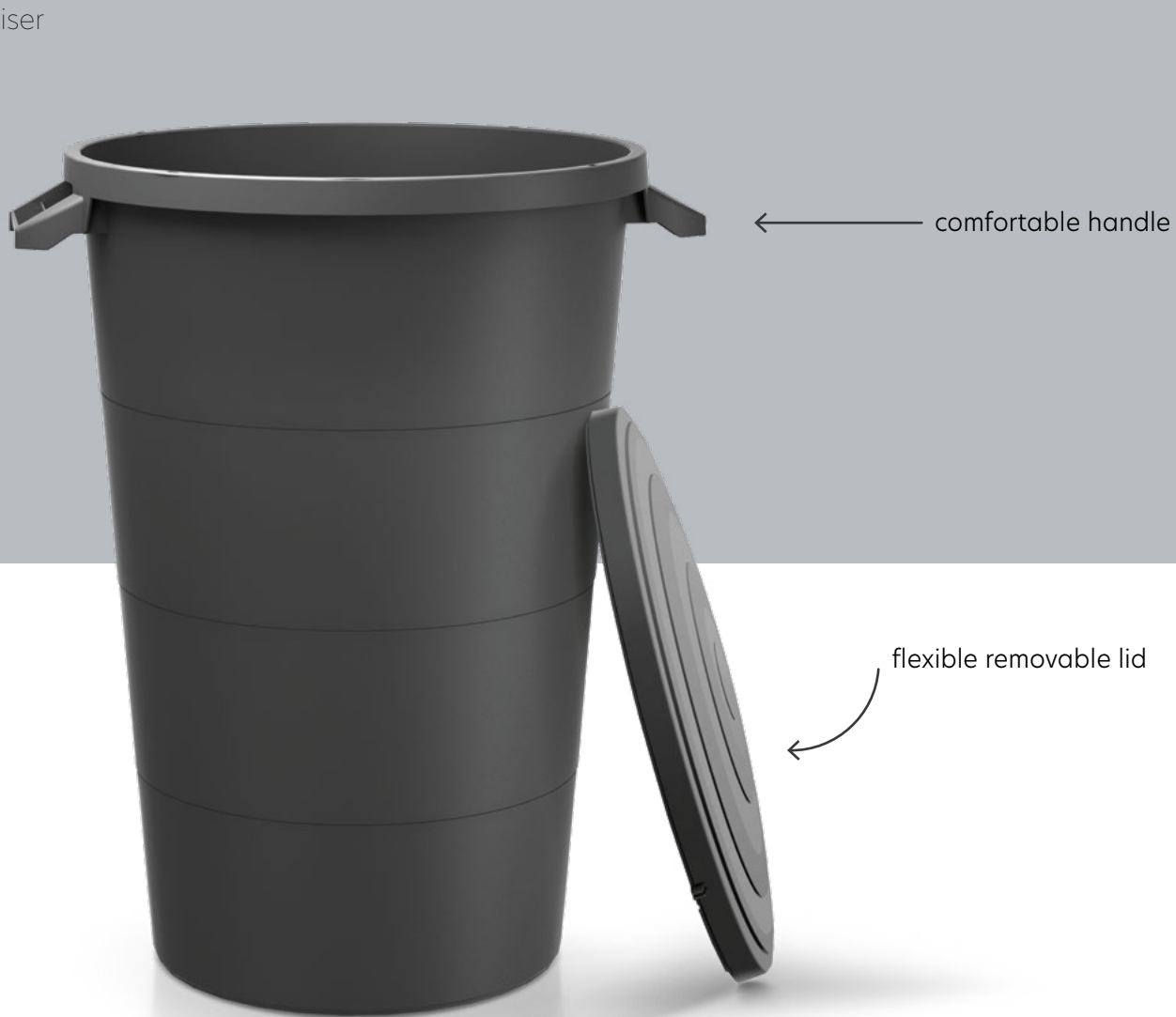

waste bin

Smooth



The Smooth bin is perfect for garden, allotment garden or office. It is made of high-quality material with high resistance to external factors. The sturdy side handles make it very easy to carry. The aesthetic lid allows you to hide the contents - it can be waste, compost, branches or rainwater. The model is available in three sizes, depending on the user's needs.

Kosz Smooth doskonale sprawdzi się w ogrodzie, na działce czy w firmie. Został wykonany z wysokogatunkowego tworzywa o podwyższonej odporności na czynniki zewnętrzne. Dzięki solidnym, bocznym uchwytom jest bardzo łatwy w przenoszeniu. Estetyczna pokrywa pozwala ukryć zawartość - mogą być to zarówno odpady, jak i kompost, gałęzie czy wodę deszczową. Model dostępny w trzech rozmiarach, zależnie od potrzeb.



Smooth



smooth	IDSM80U	IDSM120U	IDSM160U
size [ l x w x h ]	565 x 464 x 650 mm	696 x 594 x 670 mm	695 x 600 x 878 mm
volume	80 L	120 L	160 L
packaging	1	1	1
pallet quantity	42	28	22
pallet height	~1,85 m	~1,90 m	~1,85 m
colour	● 429U ● S411*	● 429U ● S411*	● 429U ● S411*

pressure resistance up to 150 kg



anti slip surface of steps and landing



two-side access steps



anti slip stopper





ladder

## Titan

The folding Titan Ladder is a practical and durable product that can be used at home, offices or even workshops. There are two sturdy, grooved steps on both sides and four elastomer feet to prevent from slipping. Thanks to practical handles, it can be carried wherever it is needed. The Titan Ladder is foldable, so it easily fits in wardrobes and places with limited space.

Rozkładana drabinka Titan Ladder to praktyczny i wytrzymały produkt, który może znaleźć zastosowanie w domu, biurach czy nawet warsztatach. Po obydwu stronach znajdują się dwa stabilne, ryflowane stopnie, a cztery stopki z elastomeru zapobiegają poślizgowi. Dzięki poręcznym uchwytnom może być przenoszona tam, gdzie akurat jest potrzebna. Drabinka Titan Ladder jest składana, więc bez problemu zmieści się w szafach i miejscach o ograniczonej przestrzeni.



Titan



Two-Side Access Step Ladder - with steps on both sides for comfortable use.

### titan

size [ l x w x h ]  
volume  
packaging  
pallet quantity  
pallet height  
colour

### KLD4565

470 x 435 x 630 mm  
-  
-  
32  
~1,90 m

 min. -18°C  
max +40°C

 2717C

up to 50%  
more space



# Spacyshoe

Spacyshoe is a practical solution that will help save space and keep wardrobes or shoe cabinets organised.

The flexible structure allows you to store shoes with a maximum height of 12 cm. Its non-slip design is recommended for storing almost all types of footwear: sandals, sneakers, moccasins and even high heels.

Spacyshoe to praktyczne rozwiązanie, które zapewni porządek i zaoszczędzi miejsce w garderobach lub w szafkach na buty.

Elastyczna struktura pozwala przechowywać obuwie o maksymalnej wysokości 12 cm. Jego antypoślizgowa konstrukcja polecana jest do przechowywania prawie wszystkich rodzajów obuwia: sandałów, trampek, mokasyń, a nawet szpilek.



spacyshoe	IOBS	IOBS5 SET	IOBM	IOBM4 SET
size [ l x w x h ]	235 x 85 x 125 mm	420 x 90 x 125 mm	270 x 100 x 145 mm	420 x 105 x 145 mm
volume	-	-	-	-
packaging	- / 105	- / 21	- / 64	- / 16
pallet quantity	1680	336	1024	256
pallet height	~1,91 m	~1,91 m	~1,91 m	~1,91 m
colour	S429  S433	S429  S433	S429  S433	S429  S433

5in1 standard set

suggested shoe size: 30-38

4in1 standard set

suggested shoe size: 38-45



# Dry pad



dry pad	IPO720
size [ l x w x h ]	716 x 348 x 33 mm
volume	-
packaging	10 / -
pallet quantity	840
pallet height	~1,86 m
colour	S411*

comfortable bags made of elastic material

perfect for shopping,  
having a picnic or going to the beach

combines an elegant design  
with classic urban style

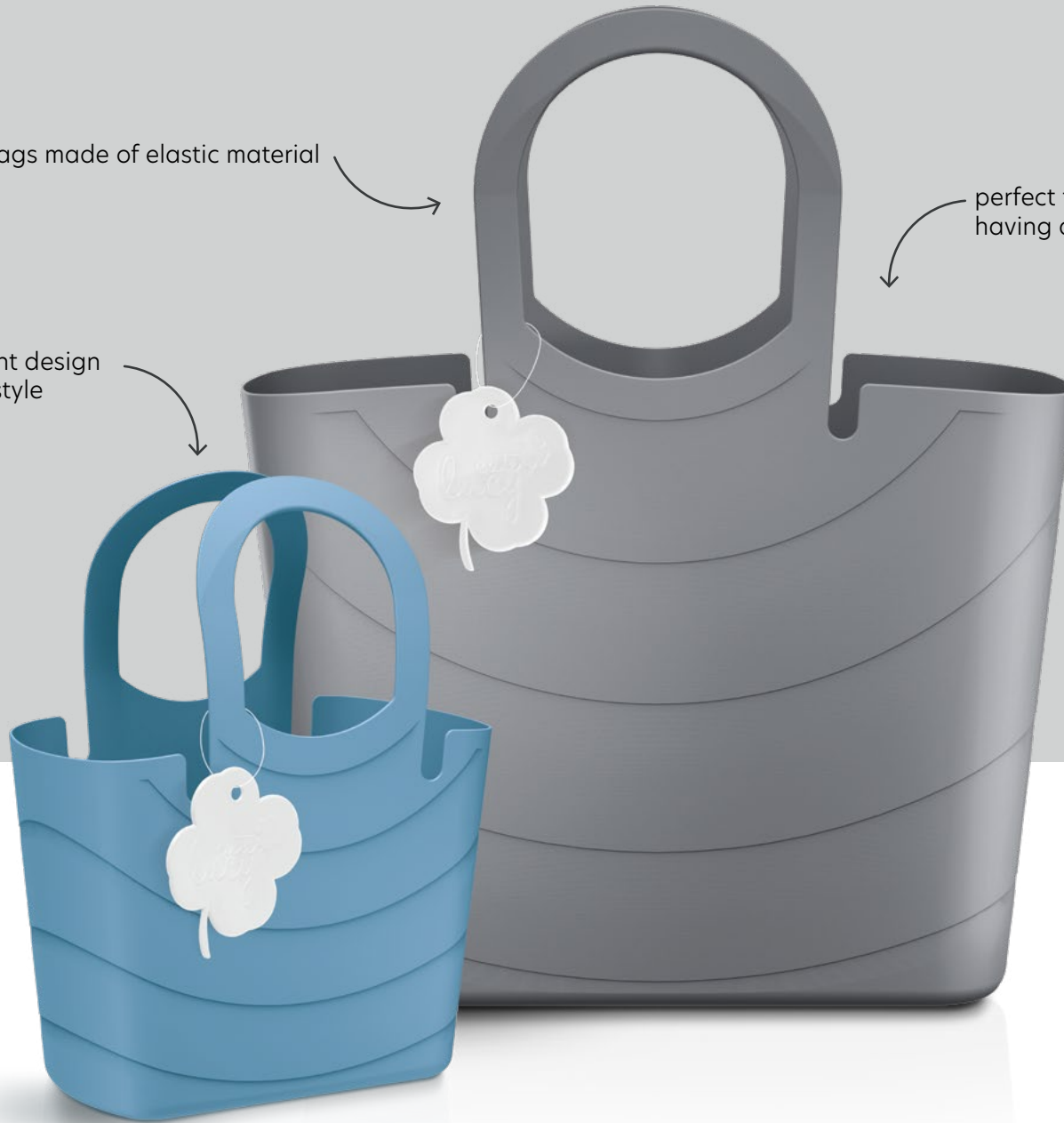

bags

## Lucy

Lucy bag made of elastic material, combines an elegant design with classic urban style. Designed for the modern woman who follows the latest fashion trends – perfect for shopping, having a picnic or going to the beach. Durable and very spacious.

Torba Lucy z elastycznego tworzywa, kombinacja eleganckiego designu i klasycznego, miejskiego fasonu. Dedykowana współczesnej kobiecie, orientującej się w zagadnieniach mody – idealna na zakupy, piknik, czy na plażę. Wytrzymała i bardzo pojemna.



Lucy



lucy	ITLU300	ITLU400	ITLU480
size [ l x w x h ]	300 x 150 x 222/383 mm	400 x 180 x 296/488 mm	477 x 190 x 357/562 mm
volume	6,5 L	15 L	24 L
packaging	10 / 20	10 / 20	10 / 20
pallet quantity	560	360	160
pallet height	~1,90 m	~1,92 m	~1,80 m
colour	● 117U ● 7476U ● 426U	● 117U ● 7476U ● 426U	● 426U

comfortable bags made of elastic material

perfect for shopping,  
having a picnic or going to the beach

combines an elegant design  
with classic urban style



# bags

# Lily



Striking Lily bag made of elastic material with imaginative ornaments and big round handles. Perfect for a modern woman who appreciates elegance and convenience.

Efektowna torebka Lily wykonana z elastycznego materiału z pomysłowymi zdobieniami i dużymi okrągłymi uchwytami. Idealny dla nowoczesnej kobiety ceniącej elegancję i wygodę.



<b>lily</b>	<b>ITLI160</b>	<b>ITLI200</b>	<b>ITLI240</b>	<b>ITLI300</b>	<b>ITLI400</b>	<b>ITLI480</b>
size [ l x w x h ]	160 x 100 x 112/191 mm	200 x 110 x 141/235 mm	240 x 122 x 169/280 mm	300 x 145 x 211/347 mm	400 x 185 x 281/460 mm	480 x 220 x 338/555 mm
volume	1,25 L	2,2 L	3,8 L	6,4 L	14,8 L	21 L
packaging	10 / 50	10 / 60	10 / 20	10 / 20	10 / 20	10 / 20
pallet quantity	1200	1080	720	560	360	160
pallet height	~1,55 m	~1,70 m	~1,70 m	~1,90 m	~1,92 m	~1,80 m
colour	● 5245U	● 5245U	● 5245U	● 5245U ● 7529U ● 623U	● 5245U ● 7529U ● 623U	● 5245U

comfortable handles

comfortable bags made of elastic material





# bags

# Billy

Spacious and durable Billy container with comfortable handles can be widely used both at home and in the garden. Billy is also distinguished by an interesting motif of a sash wrapped around its structure.

Pojemnik Billy z elastycznego tworzywa w 3 rozmiarach. Pojemny i mocny, z wygodnymi uchwytami ma szerokie zastosowanie zarówno w domu jak i w ogrodzie. Billy wyróżnia się także ciekawym motywem oplatającej go szarfy.



Billy



<b>billy</b>	<b>IPBI340</b>	<b>IPBI420</b>	<b>IPBI480</b>
size [ l x w x h ]	338 x 338 x 256 mm	423 x 423 x 318 mm	482 x 482 x 362 mm
volume	15 L	30 L	45 L
packaging	10 / -	10 / -	5 / -
pallet quantity	900	440	300
pallet height	~1,70 m	~1,80 m	~1,60 m
colour	○ S449 ● 389U ● S411	○ S449 ● 389U ● S411	○ S449 ● 389U ● S411

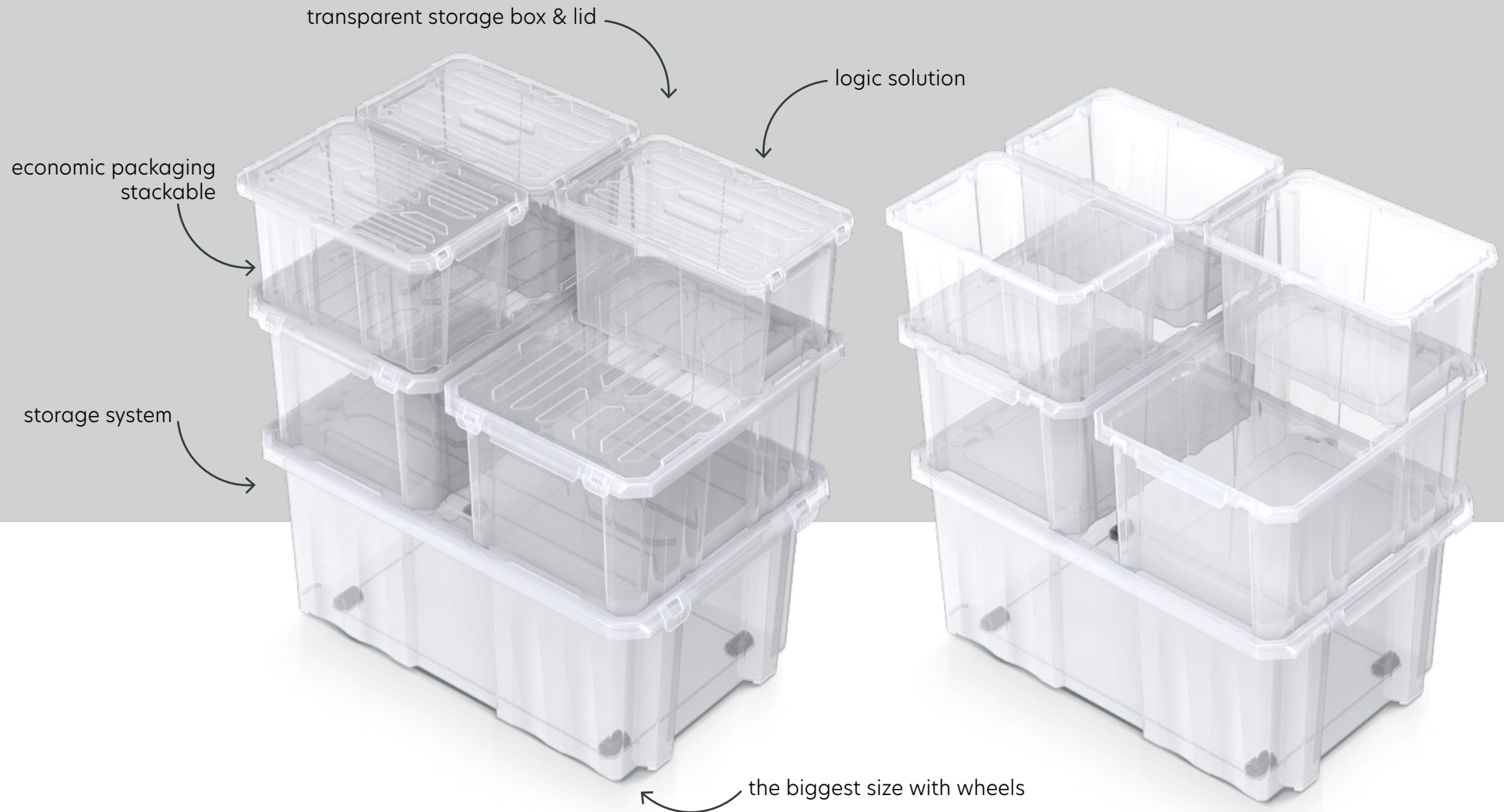

# Cargobox & Cargolid

Veristalle Cargobox containers are a must-have at home, work or in the workshop. Thanks to the transparent surface, its contents are always visible, which makes it easier to search for stored items. Cargobox containers also help to save space. Their innovative design allows stacking containers both with and without a lid, and special lugs guarantee their stability. Mounted wheels in the bottom increase its usability. Capacity from 6 l to 45 l.

Uniwersalne pojemniki Cargobox to obowiązkowa pozycja w domu, pracy czy warsztacie. Można w nich trzymać zabawki, pamiątki rodzinne, ozdoby choinkowe, narzędzia, ubrania czy buty - i na tym oczywiście nie kończy się lista jego możliwych zastosowań. Dzięki transparentnej powierzchni jego zawartość jest zawsze widoczna, co sprawia, że nie trzeba marnować czasu na poszukiwanie przechowywanych przedmiotów. Pojemniki Cargobox to również ogromna oszczędność miejsca - ich innowacyjna konstrukcja umożliwia piętrowanie pojemników zarówno z pokrywą, jak i bez; specjalne wypusty gwarantują ich stabilność. Kółka zamontowane w dnie zwiększają walory użytkowe. Pojemności: od 6 l do 45 l.



<b>cargolid</b>	<b>NCP12</b>	<b>NCP16</b>	<b>NCP24</b>
size [ l x w x h ]	300 x 200 x 20 mm	400 x 300 x 30 mm	600 x 400 x 35 mm
volume	-	-	-
packaging	10 / 60	10 / 40	5 / -
pallet quantity	1440	640	360
pallet height	~1,80 m	~1,95 m	~1,95 m
colour	S429	S429	S429



<b>cargobox</b>	<b>NCC12</b>	<b>NCC16</b>	<b>NCC24</b>
size [ l x w x h ]	300 x 200 x 165 mm	400 x 300 x 200 mm	600 x 400 x 265 mm
volume	6 L	16 L	45 L
packaging	10 / -	10 / -	5 / -
pallet quantity	640	280	120
pallet height	~1,95 m	~1,95 m	~1,95 m
colour	S429	S429	S429



NCP12 + NCC12



NCP16 + NCC16



NCP24 + NCC24



universal storage system "made to measure"



comfortable handle

anti-slip stoppers

practical wheels

# organisers

# Nuk

Smart and effective 'made to measure' NUK storage system. Its biggest advantage is its handiness, capacity and the ability to quickly move from place to place. The containers are made of a flexible, transparent material, making it easier to locate items inside. The wheels and the handle ensure mobility and easy sliding in the cabinet, and its smooth surfaces ensure easier cleaning.

Inteligentny i efektywny system przechowywania "na miarę" NUK. Jego największą zaletą jest poręczność, pojemność i możliwość szybkiego przenoszenia z miejsca na miejsce. Pojemniki wykonane są z elastycznego przezroczystego tworzywa, ułatwiającego zlokalizowanie przedmiotów znajdujących się wewnątrz. Kółka oraz rączka zapewniają mobilność i łatwe przesuwanie w komorze szafki, a jego gładkie powierzchnie ułatwiają czyszczenie.



Nuk



nuk	NUK1L	NUK3L	NUK3H	NUK4L	NUK5L	NUK5H
size [ l x w x h ]	279 x 120 x 120 mm	380 x 177 x 180 mm	380 x 177 x 256 mm	480 x 177 x 256 mm	380 x 379 x 256 mm	380 x 379 x 379 mm
volume	3 L	10 L	14 L	17 L	29 L	44 L
packaging	12 / 72	3 / -	3 / -	3 / -	3 / -	3 / -
pallet quantity	864	360	324	270	180	162
pallet height	~1,83 m	~1,80 m	~1,80 m	~1,90 m	~1,90 m	~1,90 m
colour	S429	S429	S429	S429	S429	S429

universal storage system "made to measure"



# organisers

## Nuk

Smart and effective 'made to measure' NUK storage system. Its biggest advantage is its handiness, capacity and the ability to quickly move from place to place. The containers are made of a flexible, transparent material, making it easier to locate items inside. The wheels and the handle ensure mobility and easy sliding in the cabinet, and its smooth surfaces ensure easier cleaning.

Inteligentny i efektywny system przechowywania "na miarę" NUK. Jego największą zaletą jest poręczność, pojemność i możliwość szybkiego przenoszenia z miejsca na miejsce. Pojemniki wykonane są z elastycznego przezroczystego tworzywa, ułatwiającego zlokalizowanie przedmiotów znajdujących się wewnątrz. Kółka oraz rączka zapewniają mobilność i łatwe przesuwanie w komorze szafki, a jego gładkie powierzchnie ułatwiają czyszczenie.



Nuk



nuk	NUK6L	NUK6H
size [ l x w x h ]	578 x 378 x 256 mm	578 x 378 x 379 mm
volume	30 L	49 L
packaging	3 / -	3 / -
pallet quantity	120	108
pallet height	~1,90 m	~1,90 m
colour	☉ S429	☉ S429

designed to store and organise a large number of small items in one place

comfortable handle

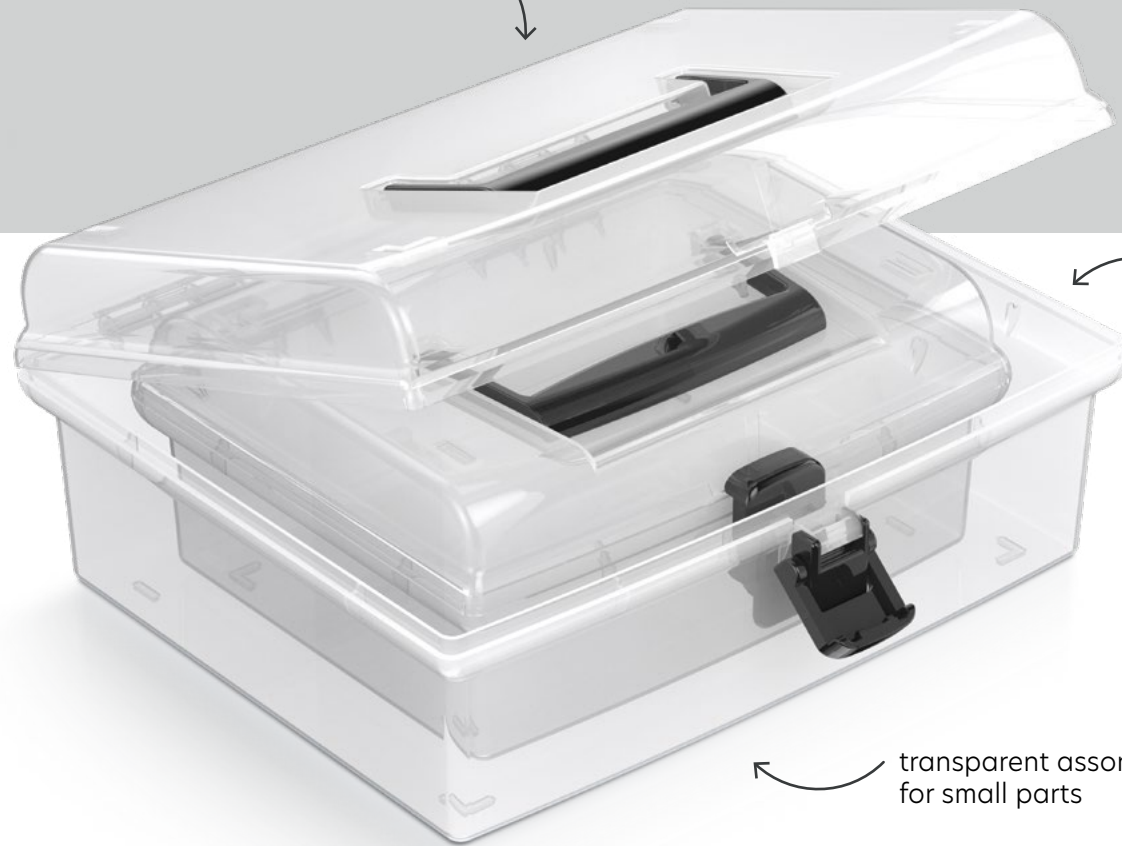

smart set 2in1  
NUF523L

transparent assortment box  
for small parts



# organisers

# Nuf low

Transparent organiser for small parts with a comfortable handle.

Przezroczysty organizer na drobne przedmioty z wygodnym uchwytem.



Nuf low



nuf low	NUF1L	NUF2L	NUF3L	NUF4L
size [ l x w x h ]	148 x 135 x 70 mm	195 x 174 x 85 mm	245 x 214 x 100 mm	292 x 290 x 116 mm
volume	-	-	-	-
packaging	- / 96	- / 40	- / 24	- / 24
pallet quantity	1152	480	288	144
pallet height	~1,83 m	~1,71 m	~1,70 m	~1,62 m
colour	S429	S429	S429	S429

nuf low set	NUFS23L set
size [ l x w x h ]	245 x 214 x 100 mm
volume	-
packaging	- / 24
pallet quantity	288
pallet height	~1,71 m
colour	S429



designed to store and organise a large number of small items in one place

comfortable handle

inner tray

smart set 2in1  
NUFS23HT

high transparent assortment box  
for small parts



organisers

# Nuf high

High transparent organiser for small parts with a comfortable handle and tray inside.

Wysoki, przezroczysty organizer na elementy drobnicowe z wygodnym uchwytem oraz tacka w środku.



Nuf high



nuf high	NUF1HT	NUF2HT	NUF3HT	NUF4HT
size [ l x w x h ]	148 x 135 x 110 mm	195 x 174 x 135 mm	245 x 214 x 158 mm	292 x 250 x 185 mm
volume	-	-	-	-
packaging	- / 60	- / 24	- / 18	- / 18
pallet quantity	720	288	162	108
pallet height	~1,83 m	~1,83 m	~1,59 m	~1,86 m
colour	S429	S429	S429	S429

nuf high set	NUFS23HT set
size [ l x w x h ]	245 x 214 x 158 mm
volume	-
packaging	- / 18
pallet quantity	162
pallet height	~1,59 m
colour	S429



# WE FOCUS ON VARIETY!



Thanks to the new technology IML - "IN-MOULD-LABELING" the possibility of colours and patterns are endless and any design request can be fulfilled



# ASK FOR MOQ

CREATE YOUR OWN BOX DESIGN



line P1



line P2



line P3



line P4



line P5



Explore Our Brands





### Woodebox

	mm	mm	mm	mm	pcs	pcs	pcs	h
MBWL140	585	460	550	140	-	1	56	~1,85 m
MBWL190	780	438	550	190	-	1	43	~1,90 m
MBWL280	1160	438	550	280	-	1	28	~1,84 m

3 sizes

440U S433



Multifunctional Storage Woodebox | Boardebox - is a perfect solution for keeping cushions, blankets, garden gadgets, smaller furniture or toys for children. The built-in loop for padlock gives you option to secure content inside. It is a practical storage box. Lightweight construction provides adequate ventilation and protection against rain. Pattern inspired by wood texture.

Available in three sizes. The smaller one will perfectly fit a small space in blocks of flats – balconies, terraces.



### Boardebox

	mm	mm	mm	mm	pcs	pcs	pcs	h
MBBL190	780	433	550	190	-	1	43	~1,90 m
MBBL280	1160	433	550	280	-	1	28	~1,84 m

2 sizes

440U S433



Available in two sizes. The smaller one will perfectly fit a small space in blocks of flats – balconies, terraces.



### Boxe Matuba

	mm	mm	mm	mm	pcs	pcs	pcs	h
MBM310	1190	480	600	310	1	1	27	~1,90 m

1 size

440U S433



It is a practical storage box easy to move around thanks to the wheels. Lightweight construction provides adequate ventilation and protection against rain. Comes in 2 different panel finishes; mosaic, patterns inspired by natural woven bamboo or rattan.







### Boxe Ratio

mm	mm	mm	mm	pcs	pcs	pcs	h	
MBR310	1190	480	600	310	1	1	27	~1,90 m

1 size

440U S433



It is a practical storage box easy to move around thanks to the wheels. Lightweight construction provides adequate ventilation and protection against rain. Comes in 2 different panel finishes; mosaic, patterns inspired by natural woven bamboo or rattan.



### Boxe Ratio Plus

mm	mm	mm	mm	pcs	pcs	pcs	h	
MBRP290	1140	470	594	290	1	1	24	~1,86 m

1 size

440U S433

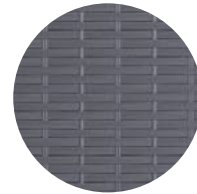

Boxe is a perfect solution for keeping cushions, blankets, garden gadgets, smaller furniture or toys for children. The built-in loop for padlock gives you option to secure content inside. Thanks to built-in wheels it can be easily moved around.



### Boxe Board

mm	mm	mm	mm	pcs	pcs	pcs	h	
MBBD290	1166	470	595	290	1	1	21	~1,86 m

1 size

440U S433



Boxe is a perfect solution for keeping cushions, blankets, garden gadgets, smaller furniture or toys for children. The built-in loop for padlock gives you option to secure content inside. Thanks to built-in wheels it can be easily moved around.









eco  
WOOD  
COLLECTION





new

**Uniqubo ECO Wood**

						
	mm	mm	mm	pcs	pcs	pcs
IKUB55TW	447	450	55	4	-	32 ~1,75m

**4665W** **4625W**

The harmony of proportions and elegant shape make this line an ideal complement for every interior and house surroundings. They are made of a lightweight, yet durable material, easy to clean and weatherproof.



new

**Zanzi Basket ECO Wood**

						
	mm	mm	mm	pcs	pcs	pcs
IKPIR 380W	374	402	25	3	-	108 ~1,88 m
IKPIR 430W	430	463	40	5	-	60 ~1,90 m

2 sizes







**CY728W** **4665W** **4625W**

The harmony of proportions and elegant shape make this line an ideal complement for every interior and house surroundings. They are made of a lightweight, yet durable material, easy to clean and weatherproof.



new

**Zoe Basket ECO Wood**

						
	mm	mm	mm	pcs	pcs	pcs
IKPIO370W	364	359	25	5	-	210 ~1,90 m
IKPIO430W	419	408	40	5	-	100 ~1,80 m

2 sizes

**CY728W** **4665W** **4625W**



eco-friendly product easier biodegradability

The technological process may affect the colour of the product.





### Uniqubo

	mm	mm	mm	pcs	pcs	pcs	h
IKUB20	337	292	20	4	-	168	~1,80 m
IKUB35	390	400	35	4	-	120	~1,92 m
IKUB55	447	450	55	4	-	48	~1,81 m

#### 3 sizes

S449 405U S433

The harmony of proportions and elegant shape make this line an ideal complement for every interior and house surroundings. They are made of a lightweight, yet durable material, easy to clean and weatherproof.



2in1  
standard set

### Uniqubo

	mm	mm	mm	pcs	pcs	h
IKUB20I	337	292	17,0/20,0	4	84	~1,77m

#### 1 size

405U S433



2in1  
standard set

### Uniqubo

	mm	mm	mm	pcs	pcs	pcs	h
IKUB35J	390	400	35	4	-	96	~1,67 m
IKUB55J	447	450	55	4	-	48	~1,92 m

#### 2 sizes

405U S433

jute sheet inside  
jute sheet 100 x 100 cm, rope 200 cm.



2in1  
standard set

### Uniqubo

	mm	mm	mm	pcs	pcs	pcs	h
IKUB35W	390	400	35	4	-	96	~1,67 m
IKUB55W	447	450	55	4	-	48	~1,92 m

#### 2 sizes

405U S433

cotton bag inside



### Yuta

	mm	mm	mm	pcs	pcs	pcs	h
IWOJ	1000	1000	1	12	1344	~1,76 m	

#### 1 size

Decorative pot jute fabric with cord.  
jute sheet 100 x 100 cm, rope 200 cm



### Unibag

	mm	mm	mm	pcs	pcs	pcs	h
IWOR35	225	160	25	1	16	1792	~1,76 m
IWOR55	255	170	20	1	12	1344	~1,76 m

#### 2 sizes



2 in 1  
standard set

### Uniqubo

	mm	mm	mm	pcs	pcs	pcs	h
IKUB5STP	447	450	55	4	-	32	~1,75m

1 size

405U S433



2 in 1  
standard set

### Uniqubo

	mm	mm	mm	pcs	pcs	pcs	h
IKUB20T	337	292	20	4	-	84	~1,77 m
IKUB35T	390	400	35	4	-	72	~1,83 m
IKUB55T	447	450	55	4	-	32	~1,75 m

3 sizes

405U S433



### Uniqubo Set 3

	mm	mm	mm	pcs	pcs	pcs	h
IKUBS3	447	450	-	-	1kpl	16	~1,95 m

405U S433

set contains:



1 basket with lid

2 seats



### Uniqubo Set 5

	mm	mm	mm	pcs	pcs	pcs	h
IKUBS5	447	570	-	-	1kpl	12	~1,86 m

405U S433

set contains:



1 basket with lid

4 seats

The Uniqubo Set3, Set5 multi-functional furniture set ensures high comfort of everyday use, and its components can be arranged as you like. The openwork seats and the table with a top made of natural material can perform very well in the recreational garden space, on the terrace or balcony, or in the home relaxation zone. They are made of a lightweight, yet durable material, easy to clean and weatherproof.



**Zanzi Basket**

	mm	mm	pcs	pcs	pcs	h
IKPIR 380	374	402	25	3	-	108 ~1,88 m
IKPIR 430	430	463	40	5	-	60 ~1,90 m

**2 sizes**

- 7501U
- S433



**Zoe Basket**

	mm	mm	pcs	pcs	pcs	h
IKPI0370	364	359	25	5	-	210 ~1,90 m
IKPI0430	419	408	40	5	-	100 ~1,80 m

**2 sizes**

- 7501U
- S433

The harmony of proportions and elegant shape make this line an ideal complement for every interior and house surroundings. They are made of a lightweight, yet durable material, easy to clean and weatherproof.





### Clubo

	mm	mm	pcs	pcs	pcs	h
ICLU25	335	330	25	5	-	315 ~1,83 m
ICLU35	386	358	35	5	-	240 ~1,80 m
ICLU50	450	410	50	5	-	90 ~1,75 m
ICLU100	590	455	100	5	-	60 ~1,90 m

4 sizes

S433



### Clubo Set

	mm	mm	pcs	pcs	pcs	h
ICLU15	386	358	-	-	1kpl	30 ~1,88 m

S433

set contains:



ICLU25 + ICLU35



### Clubo Set

	mm	mm	pcs	pcs	pcs	h
ICLU35	590	455	-	-	1kpl	8 ~1,87 m

S433

set contains:



ICLU50 + ICLU100



### Clubo Set

	mm	mm	pcs	pcs	pcs	h
ICLU25	450	410	-	-	1kpl	12 ~1,67 m

S433

set contains:



ICLU35 + ICLU50



### Clubo Set

	mm	mm	pcs	pcs	pcs	h
ICLU45	590	455	-	-	1kpl	8 ~1,87 m

S433

set contains:



ICLU25 + ICLU35 + ICLU50 + ICLU100



### Dry Pad

	← mm	↘ mm	↑ mm	📄 pcs	📦 pcs	📏 pcs	📏 h
IP0720	716	348	33	-	10	-	840 ~1,86 m

1 size

S411

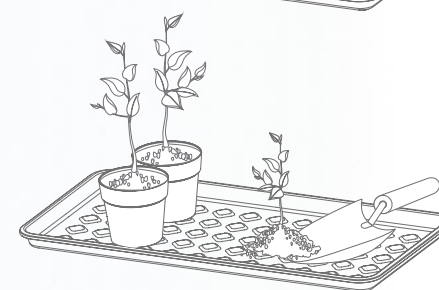
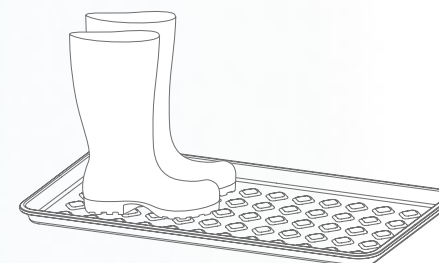

multifunctional usage





### Multi Holder

	mm	mm	mm	kg	pcs	pcs	pcs	h
IWN1	310	98	70	7	5	40	720	~1,82 m

405U

A modern, wall-mountable holder with rubber finish. Solves the problem of keeping portable tools perfectly and organised.



#### IWN1

Option 1  
Wall-mounting



Option 2  
Toolboard-mounting



### Multi Holder

	mm	mm	mm	kg	pcs	pcs	pcs	h
IWN2	597	128	118	15	4	20	200	~1,77 m

405U



#### IWN2

Option 1  
Wall-mounting



















Explore Our Brands

 **Kistenberg**

# Smart tool box



	SMART tool box	SMART tool box	SMART tool box	SMART tool box set
	KSM32	KSM40	KSM50	KSMS40
colour	 	 	 	 
 mm	328 x 178 x 160	380 x 234 x 225	500 x 251 x 243	380 x 234 x 225
 kg	~ 6	~ 8,5	~ 12	~ 6 / ~ 8,5
 pcs	-	-	-	-
 pcs	154	80	49	80
 mm	~ 1880	~ 1900	~ 1800	~ 1900
	ABS latches, ergonomic handle, tray	ABS latches, ergonomic handle, tray	ABS latches, ergonomic handle, tray	ABS latches, ergonomic handle, smart set 2in1, trays

## SMART:

- Modern design
- Ergonomic handle
- Durable ABS fasteners
- Inner tray



KSM32 + KSM40  
**SET 2IN1**

You craft, we store.



	<b>SMART</b> tool box	<b>SMART</b> tool box	<b>SMART</b> tool box	<b>SMART</b> tool box	<b>SMART</b> tool box
	KSML32 - K1	KSML40 - K1	KSML32 - K2	KSML40 - K2	KSMA50F
colour	4C	4C	4C	4C	3020 4C
mm	328 x 178 x 160	380 x 234 x 225	328 x 178 x 160	380 x 234 x 225	500 x 251 x 243
kg	~ 6	~ 8,5	~ 6	~ 8,5	~ 12
pcs	-	-	-	-	-
pcs	154	80	154	80	49
mm	~ 1880	~ 1900	~ 1880	~ 1900	~ 1810
	ABS latches, ergonomic handle, tray, IML lid	ABS latches, ergonomic handle, tray, IML lid	ABS latches, ergonomic handle, tray, IML lid	ABS latches, ergonomic handle, tray, IML lid	ABS latches, ergonomic alu handle, tray, organiser with boxes in the lid







**SMART:**

- Modern personalized design
- Ergonomic handle
- Durable ABS fasteners
- Inner tray



# Nort & Knox organiser



	KNOX organiser		NORT organiser		NORT organiser	
	KKNO2010	KKNO2015	KNO20154T	KNO30204T	KNO35255T	KNO40307T
colour	S429	S429	S429	S429	S429	S429
 mm	180 x 90 x 35	200 x 160 x 35	195 x 155 x 35	290 x 195 x 35	344 x 249 x 50	390 x 290 x 65
 kg	-	-	-	-	-	-
 pcs	-/120	-/60	-/48	15/60	10/-	10/-
 pcs	2160	1080	1152	720	340	200
 mm	~ 1700	~ 1700	~ 1800	~ 1700	~ 1900	~ 1800
	transparent organisers for small parts, fixed separators		organisers for small parts, removable separators, transparent		organisers for small parts, removable separators, transparent	

**NORT:**

- Designed to store and organise a large number of small items in one place
- Available in 4 sizes,
- Removable separators which help to personalise the storage space
- Transparent organisers



You craft, we store.

# Nun organiser



	NUN organiser	NUN organiser	NUN organiser	NUN organiser	NUN organiser
	KNU20	KNU25	KNU30	KNU36	KNU40
colour	S429	S429	S429	S429	S429
mm	198 x 117 x 45	245 x 150 x 85	295 x 195 x 85	359 x 238 x 85	400 x 298 x 85
kg	-	-	-	-	-
pcs	- / 45	- / 38	- / 24	- / 16	- / 12
pcs	1080	456	288	160	144
mm	~ 1900	~ 1700	~ 1700	~ 1770	~ 1830
	transparent organiser, fixed separators, hanging loop	transparent organiser, fixed separators, comfortable handle	transparent organiser, fixed separators, comfortable handle	transparent organiser, removable separators, comfortable handle	transparent organiser, removable separators, comfortable handle





You craft, we store.



✓ correct use

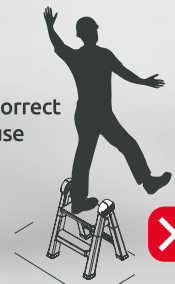

✗ incorrect use



# Titan Ladder

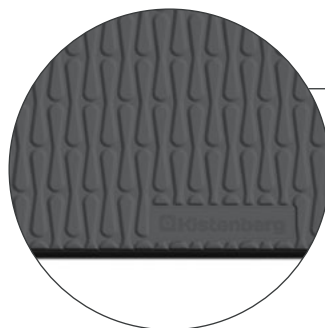

new

Two-Side access steps

Anti slip stopper

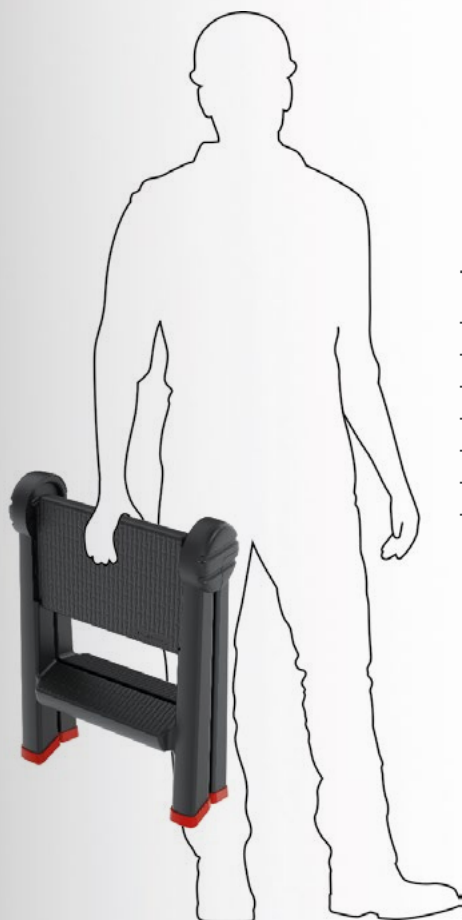

## TITAN LADDER:

- Folding ladder
- Body made of reinforced structure
- EN-14183 : 2003 certificate
- Anti slip surface of steps and landing
- Anti slip stopper
- Pressure resistance up to 150 kg
- Steps on two sides



Two-Side access steps

		TITAN ladder
		KLD4565
	colour	S411
	mm	470 x 435 x 630
	kg	~ 150
	pcs	-
	pcs	32
	mm	~ 1900
	Two-Side Access Step Ladder - with steps on both sides for comfortable use	



min. -18°C  
max +40°C

## color palette

☐ S429	przeźraczysty transparent	● 2717C	jasny niebieski soft blue
○ S449	biały white	● 2383C	niebieski blue
● 427C	popielaty ashen	● 7476U	blue jeans blue jeans
● WG5C	jasny brąz soft brown	● 5245U	jagodowy jasny light berry
● 7529U	mocca mocca	● 429U	smooth gray smooth gray
● 4665W	natura ECO ECO nature	● 405U	szary kamienny stone gray
● 117U	musztardowy mustard	● 426U	grafit graphite
● 7589C	brąz brown	● S433	antracytowy anthracite
● 1215C	jasny żółty soft yellow	● S433W	antracytowy ECO ECO anthracite
● 120C	żółty yellow	● S411*	czarny recykling recycled black
● 389U	limonka lime	● S411	czarny black
● 362C	zielony green		
● 623U	szałwia sage		
● 5575C	jasny zielony soft green		

small changes  
for better life



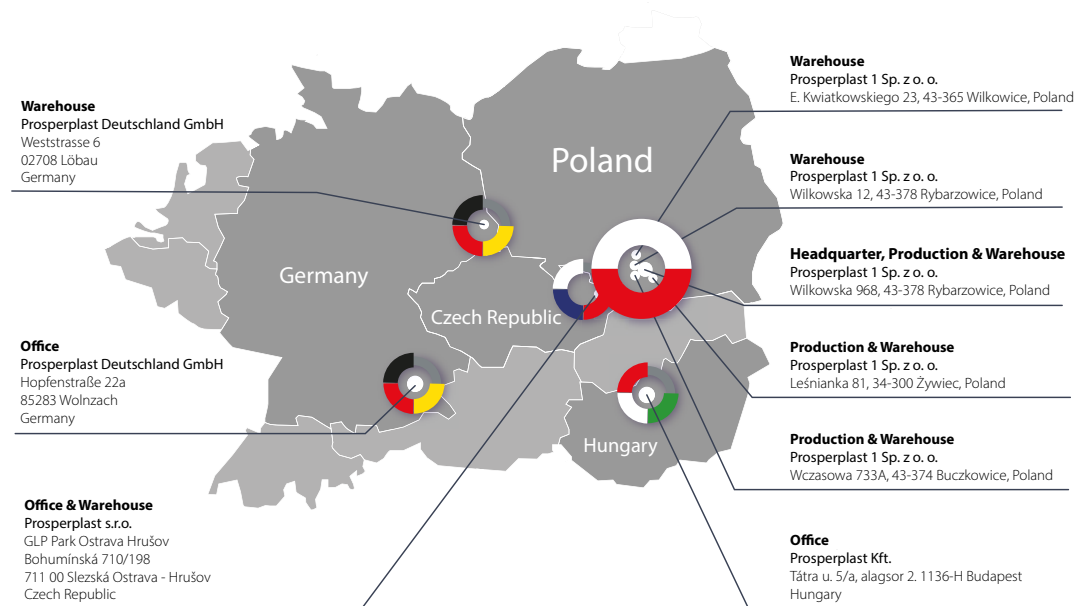

## Contact us



### Headquarter, Production & Warehouse

Prosperplast 1 Sp. z o. o.  
Wilkowska 968  
43-378 Rybarzowice  
Poland

tel. +48 33 817 70 03  
fax +48 33 817 60 81

biuro@prosperplast.pl  
office@prosperplast.pl  
www.prosperplast.pl



### Office

Prosperplast Deutschland GmbH  
Hopfenstraße 22a  
85283 Wolnzach  
Germany

tel. +49 8442 9628499  
tel. +49 8442 9588 30  
fax +49 8442 9680853

kontakt@prosperplast.de  
www.prosperplast.de



### Office & Warehouse

Prosperplast s.r.o.  
GLP Park Ostrava Hrušov  
Bohumínská 710/198  
711 00 Slezská Ostrava - Hrušov  
Czech Republic

tel. +420 553 034 443  
mob +420 605 499 544

info@prosperplast.cz  
www.prosperplast.cz



### Office

Prosperplast Kft.  
Tátra u. 5/a, alagsor 2.  
1136-H Budapest,  
Hungary

tel. +36 30 4095 120  
mob +36 30 4095 710

office@prosperplast.hu  
www.prosperplast.hu



Prosperplast 1 Sp. z o.o.  
Wilkowska 968  
43-378 Rybarzowice  
Poland

[keden.pl](https://keden.pl)

Feel free to place your order via B2B